

GOOSE

HOSES
AND
FITTINGS

Fittings measures and types

The DASH classification (eg -06) replaced the measures for the AN (Army-Navy specifications) series.

The DASH value currently in use do not indicate a specific measure but only a classification.

For example, a -06 fitting has a 9/16-18 UNF thread and can be used with a -06 hose.

The table below indicate the UNF measures compatible with the corresponding AN/Dash categories, and NPT and BSP specifications.

J.I.C. 37° (AN) fittings from D-02 to D-16

Dash	UNF (") thread	outer Ø (mm)	inner Ø (mm)	Hexagon (mm)
D-02	5/16 x 24	7,94	6,85	9,52
D-03	3/8 x 24	9,52	8,73	11,12
D-04	7/16 x 20	11,07	10,00	14,25
D-06	9/16 x 18	14,25	13,00	17,50
D-08	3/4 x 16	19,00	17,60	22,20
D-10	7/8 x 14	22,17	20,50	25,30
D-12	1 1/16 x 12	26,95	25,00	31,80
D-16	1 5/16 x 12	33,30	31,30	38,20

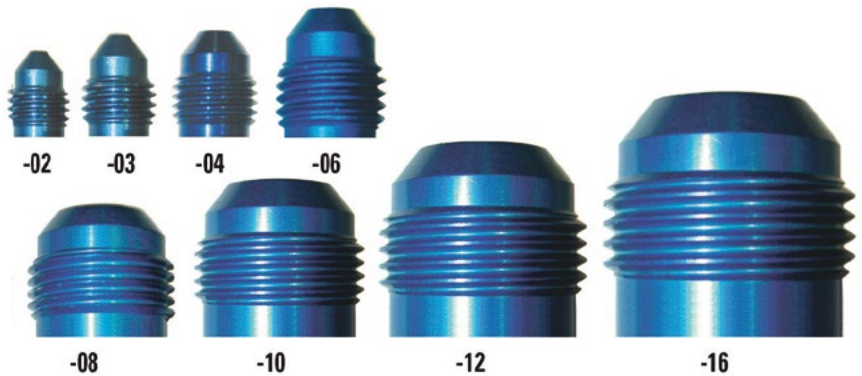

NPT fittings from 1/8 to 3/4

Measure	NPT (") thread	outer Ø (mm)	end
1/8	1/8 x 27	10,00	conical
1/4	1/4 x 19	13,60	conical
3/8	3/8 x 18	17,00	conical
1/2	1/2 x 14	21,00	conical
3/4	3/4 x 14	26,00	conical
1	1 x 11 1/2	33,00	conical

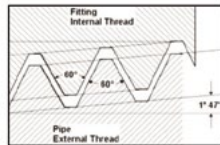

BSP fittings from 1/8 to 5/8

Measure	BSP (") thread	outer Ø (mm)	inner Ø (mm)
1/8	1/8 x 28	9,7	8,6
1/4	1/4 x 19	13,1	11,6
3/8	3/8 x 19	16,7	15,1
1/2	1/2 x 14	21,0	18,9
5/8	5/8 x 14	22,9	20,9



Materials

In the hoses and fittings section we have conventionally used abbreviations to identify the main materials with which the products are made, unless otherwise indicated:

KEY OF MATERIALS

- B:** Brass
- C:** Stainless steel
- CH:** Chrome plated
- D:** Aluminium
- P:** Zinc plated carbon steel
- Z1:** Silver plated carbon steel

G-LINE ULTRA™

THE ULTIMATE PTFE LINED FLEXIBLE HOSE



G-Line Ultra 860 & 960 are the most robust hoses in the Goodridge range; used by motorsport teams globally who require the highest level of protection from temperature, high pressure, vacuum resistance and kink resistance.

Similar to the Goodridge G-Line XF range, G-Line Ultra features a smooth bore, externally convoluted, carbon impregnated, anti-static PTFE liner.

In addition, the G-Line Ultra range features a helically wound high tensile 316 stainless steel coil, seated between the external convolutions of the PTFE hose liner. The coil increases burst pressures, vacuum resistance and kink resistance.

G-Line Ultra is compatible with 960 crimp fittings and must be assembled using specialist equipment. Double swivel tail options are available to aid with alignment.

The G-Line Ultra hose range is a popular choice for leading motorsport teams.

Benefits:

- Uninterrupted flow
- Burst pressure up to 6090 PSI / 420 BAR (AN-06)
- Temperature resistance from -40°C to +180°C
- Vacuum resistance to -13.05 PSI / -0.9 BAR
- Bend radius to 25mm (AN-06)

Features:

- Enlarged smooth bore
- Stainless steel helically wound coil
- PTFE lined
- Aramid fibre / Stainless steel braided option
- SAE J1737 compliant

Fluid applications:

Fuel, Oil, Water, Methanol & Pneumatics

Compatible fittings:

960 Ultra lightweight crimp fittings (Not compatible with reusable fittings)

Please Note:

Volumetric expansion and flow data available on request



The G Line Ultra hose range is the 'go to' hose for high burst pressure, vacuum resistance and kink resistance. The G-Line Ultra range features a helically wound high tensile 316 stainless steel coil, seated between the external convolutions of the smooth bore PTFE hose liner. This feature increases burst pressures, vacuum resistance and kink resistance over a conventional PTFE lined smooth bore hose. The 960 version features an aramid fibre outer braid (as opposed to Stainless Steel 860), making the hose ideal when weight saving is critical.

Note: Temperature affects maximum working pressure as listed; for temps above 1300C reduce the working pressure by 0.75% for each degree above 1300C Max 1800C.

Fluid applications:
Fuel, Oil, Water, Methanol & Pneumatics

Material:
Anti-static PTFE smoothbore, aramid fibre braid

Compatible fittings:
960 Ultra Lightweight crimp fittings
(Not compatible with any reusable fittings)

Notes:
Collars must be purchased separately.

Code	Dash No	Bore size mm (in)	Nominal hose OD mm (in)	Working pressure BAR (PSI)	Burst pressure BAR (PSI)	Weight Kg/m (Lb/Ft)	Min. bend radius mm (in)	Temperature range °C (°F)
960-06	-06	9,94 (0,39)	13,59 (0,54)	140 (2031)	420 (6092)	0,10 (0,067)	19,0 (0,75)	-40/+180 (-40/+356)
960-08	-08	13,2 (0,52)	17,6 (0,69)	122 (1769)	367 (5323)	0,18 (0,121)	28,0 (1,10)	-40/+180 (-40/+356)
960-10	-10	16,70 (0,66)	21,60 (0,85)	113 (1639)	341 (4945)	0,26 (0,175)	32,0 (1,26)	-40/+180 (-40/+356)
960-12	-12	20,05 (0,79)	25,15 (0,99)	105 (1523)	315 (4568)	0,31 (0,208)	35,0 (1,38)	-40/+180 (-40/+356)
960-16	-16	26,10 (1,03)	32,35 (1,27)	87 (1262)	262 (3780)	0,50 (0,336)	50,0 (1,97)	-40/+180 (-40/+356)
960-20	-20	32,60 (1,28)	39,20 (1,54)	78 (1131)	236 (3423)	0,74 (0,500)	70,0 (2,76)	-40/+180 (-40/+356)



The G Line Ultra hose range is the 'go to' hose for high burst pressure, vacuum resistance and kink resistance. The G-Line Ultra range features a helically wound high tensile 316 stainless steel coil, seated between the external convolutions of the smooth bore PTFE hose liner. This feature increases burst pressures, vacuum resistance and kink resistance over a conventional PTFE lined smooth bore hose. The 860 version features a stainless-steel outer braid (as opposed to the aramid fibre 960), offering the highest level of protection from abrasion, tighter bend radius and higher temp resistance.

Note: Temperature affects maximum working pressure as listed; for temps above 130° C reduce the working pressure by 0.75% for each degree above 130° C. Max 260° C.

Fluid applications:
Fuel, Oil, Water, Methanol & Pneumatics

Material:
Anti-static PTFE smoothbore, stainless-steel outer braid

Compatible fittings:
960 Ultra Lightweight crimp fittings
(Not compatible with any reusable fittings)

Notes:
Collars must be purchased separately.

Code	Dash No	Bore size mm (in)	Nominal hose OD mm (in)	Working pressure BAR (PSI)	Burst pressure BAR (PSI)	Weight Kg/m (Lb/Ft)	Min. bend radius mm (in)	Temperature range °C (°F)
860-06	-06	9,94 (0,39)	13,26 (0,52)	140 (2031)	420 (6092)	0,14 (0,094)	19,0 (0,75)	-73/+260 (-99/+500)
860-08	-08	13,13 (0,52)	17,60 (0,69)	122 (1769)	367 (5323)	0,29 (0,194)	28 (1,10)	-73/+260 (-99/+500)
860-10	-10	16,30 (0,64)	21,50 (0,85)	113 (1639)	341 (4945)	0,35 (0,235)	32,0 (1,26)	-73/+260 (-99/+500)
860-12	-12	19,5 (0,76)	24,90 (0,98)	105 (1523)	315 (4568)	0,40 (0,290)	35,0 (1,38)	-73/+260 (-99/+500)
860-16	-16	25,9 (1,02)	31,8 (1,25)	87 (1262)	262 (3780)	0,63 (0,423)	50,0 (1,97)	-73/+260 (-99/+500)

CRIMP FITTINGS

B: Brass - C: Stainless steel - CH: Chrome plated - D: Aluminium - P: Zinc plated carbon steel - Z1: Silver plated carbon steel

960 JIC Fittings for G-Line Ultra 960 & 860 hose



960-01
Straight female concave seat

Code	To suit hose	Thread	Mat
960-0106	-06	9/16 x 18	D
960-0108	-08	3/4 x 16	D
960-0110	-10	7/8 x 14	D
960-0112	-12	1 1/16 x 12	D
960-0116	-16	1 5/16 x 12	D
960-0120	-20	1 5/8 x 12	D



960-120
120° swept tube female concave seat

Code	To suit hose	Thread	Mat
960-12006	-06	9/16 x 18	D
960-12008	-08	3/4 x 16	D
960-12010	-10	7/8 x 14	D
960-12012	-12	1 1/16 x 12	D
960-12016	-16	1 5/16 x 12	D



960-45
45° forged female concave seat

Code	To suit hose	Thread	Mat
960-4506	-06	9/16 x 18	D
960-4508	-08	3/4 x 16	D
960-4510	-10	7/8 x 14	D
960-4512	-12	1 1/16 x 12	D



960-150
150° swept tube female concave seat

Code	To suit hose	Thread	Mat
960-15006	-06	9/16 x 18	D
960-15008	-08	3/4 x 16	D
960-15010	-10	7/8 x 14	D
960-15012	-12	1 1/16 x 12	D
960-15016	-16	1 5/16 x 12	D



960-46
45° swept tube female concave seat

Code	To suit hose	Thread	Mat
960-4606	-06	9/16 x 18	D
960-4608	-08	3/4 x 16	D
960-4610	-10	7/8 x 14	D
960-4612	-12	1 1/16 x 12	D
960-4616	-16	1 5/16 x 12	D
960-4620	-20	1 5/8 x 12	D



960-180
180° swept tube female concave seat

Code	To suit hose	Thread	Mat
960-18006	-06	9/16 x 18	D
960-18008	-08	3/4 x 16	D
960-18010	-10	7/8 x 14	D
960-18012	-12	1 1/16 x 12	D
960-18016	-16	1 5/16 x 12	D



960-90
90° forged female concave seat

Code	To suit hose	Thread	Mat
960-9006	-06	9/16 x 18	D
960-9008	-08	3/4 x 16	D
960-9010	-10	7/8 x 14	D
960-9012	-12	1 1/16 x 12	D



96776
Straight banjo

Code	To suit hose	Thread	Mat
96776-06-M12D	-06	M12 x 1,5	D
96776-06-M14D	-06	M14 x 1,5	D

960 JIC Fittings for G-Line Ultra 960 & 860 hose (made to order)



960-91
90° swept tube female concave seat

Code	To suit hose	Thread	Mat
960-9106	-06	9/16 x 18	D
960-9106-M14	-06	M14 x 1,5	D
960-9108	-08	3/4 x 16	D
960-9110	-10	7/8 x 14	D
960-9112	-12	1 1/16 x 12	D
960-9116	-16	1 5/16 x 12	D
960-9120	-20	1 5/8 x 12	D



960-30
30° swept tube female concave seat

Code	To suit hose	Thread	Mat
960-3008	-08	3/4 x 16	D
960-3010	-10	7/8 x 14	D
960-3012	-12	1 1/16 x 12	D
960-3016	-16	1 5/16 x 12	D



960-60
60° swept tube female concave seat

Code	To suit hose	Thread	Mat
960-6008	-08	3/4 x 16	D
960-6010	-10	7/8 x 14	D
960-6012	-12	1 1/16 x 12	D
960-6016	-16	1 5/16 x 12	D

CRIMP FITTINGS

B: Brass - C: Stainless steel - CH: Chrome plated - D: Aluminium - P: Zinc plated carbon steel - Z1: Silver plated carbon steel

960 Double Swivel JIC Fittings for G-Line Ultra 960 & 860 hose



Double swivel forged 45° female concave seat

Code	To suit hose	Thread	Mat
9945-06	-06	9/16 x 18	D
9945-08	-08	3/4 x 16	D
9945-10	-10	7/8 x 14	D
9945-12	-12	1 1/16 x 12	D



Double swivel swept tube 120° female concave seat

Code	To suit hose	Thread	Mat
99120-08	-08	3/4 x 16	D
99120-10	-10	7/8 x 14	D
99120-12	-12	1 1/16 x 12	D
99120-16	-16	1 5/16 x 12	D



Double swivel forged 90° female concave seat

Code	To suit hose	Thread	Mat
9990-06	-06	9/16 x 18	D
9990-08	-08	3/4 x 16	D
9990-10	-10	7/8 x 14	D
9990-12	-12	1 1/16 x 12	D



Double swivel swept tube 150° female concave seat

Code	To suit hose	Thread	Mat
99150-08	-08	3/4 x 16	D
99150-10	-10	7/8 x 14	D
99150-12	-12	1 1/16 x 12	D
99150-16	-16	1 5/16 x 12	D



Double swivel swept tube 90° female concave seat

Code	To suit hose	Thread	Mat
9991-08	-08	3/4 x 16	D
9991-10	-10	7/8 x 14	D
9991-12	-12	1 1/16 x 12	D
9991-16	-16	1 5/16 x 12	D



Double swivel swept tube 180° female concave seat

Code	To suit hose	Thread	Mat
99180-08	-08	3/4 x 16	D
99180-10	-10	7/8 x 14	D
99180-12	-12	1 1/16 x 12	D
99180-16	-16	1 5/16 x 12	D

960 Double Swivel JIC Fittings for G-Line Ultra 960 & 860 hose (made to order only)



Double swivel swept tube 30° female concave seat

Code	To suit hose	Thread	Mat
9930-08	-08	3/4 x 16	D
9930-10	-10	7/8 x 14	D
9930-12	-12	1 1/16 x 12	D
9930-16	-16	1 5/16 x 12	D



Straight concave seat DFL for Wiggins/Hydraflow

Code	To suit hose	Mat
960-0108DFL	-08	D
960-0110DFL	-10	D
960-0112DFL	-12	D
960-0116DFL	-16	D



Double swivel swept tube 45° female concave seat

Code	To suit hose	Thread	Mat
9946-08	-08	3/4 x 16	D
9946-10	-10	7/8 x 14	D
9946-12	-12	1 1/16 x 12	D
9946-16	-16	1 5/16 x 12	D



45° DFL for Wiggins/Hydraflow female concave seat

Code	To suit hose	Mat
960-4508DFL	-08	D
960-4510DFL	-10	D
960-4512DFL	-12	D
960-4516DFL	-16	D



Double swivel swept tube 60° female concave seat

Code	To suit hose	Thread	Mat
9960-08	-08	3/4 x 16	D
9960-10	-10	7/8 x 14	D
9960-12	-12	1 1/16 x 12	D
9960-16	-16	1 5/16 x 12	D



90° DFL for Wiggins/Hydraflow female concave seat

Code	To suit hose	Mat
960-9008DFL	-08	D
960-9010DFL	-10	D
960-9012DFL	-12	D
960-9016DFL	-16	D

CRIMP FITTINGS

B: Brass - C: Stainless steel - CH: Chrome plated - D: Aluminium - P: Zinc plated carbon steel - Z1: Silver plated carbon steel

960 Wiggins/Hydraflow Cup DFL fittings for G-Line Ultra 960 & 860 hose (Made to order)



120° DFL for Wiggins/Hydraflow female concave seat

Code	To suit hose	Mat
960-12008DFL	-08	D
960-12010DFL	-10	D
960-12012DFL	-12	D
960-12016DFL	-16	D

Crimp collar to suit 960 Fittings



Crimp collar for 960 and 860 hoses

Code	To suit hose	Thread	Mat
RCC960-06D	-06	-	D
RCC960-08D	-08	-	D
RCC960-10D	-10	-	D
RCC960-12D	-12	-	D
RCC960-16D	-16	-	D
RCC960-20D	-20	-	D



150° DFL for Wiggins/Hydraflow female concave seat

Code	To suit hose	Mat
960-15008DFL	-08	D
960-15010DFL	-10	D
960-15012DFL	-12	D
960-15016DFL	-16	D



180° DFL for Wiggins/Hydraflow female concave seat

Code	To suit hose	Mat
960-18008DFL	-08	D
960-18010DFL	-10	D
960-18012DFL	-12	D
960-18016DFL	-16	D





G-LINE

G-Line hose and fittings are used by leading motorsport teams requiring a combination of high flow rate, protection from the elements, tight bend radii and reduced weight.

The G-Line hose range is available in smoothbore (XF910 and XF811) and convoluted (G-Flex 711 and G-Line 710) hose options. All G-Line hoses either feature as standard or have an anti-static PTFE liner option.

In addition, bespoke lightweight aluminium fittings, available in crimp, draw swage and reusable tail options are available. Double swivel tail options are available to aid with alignment. Current customers include teams competing in F1, INDYCAR, WEC, NASCAR, WRC, GT, BTCC, WTCR and club level motorsports.

Benefits:

- Super light weight (XF910 & G-Flex 711)
- Uninterrupted flow
- Burst pressure up to 5076 PSI / 350 BAR (AN-04)
- Temperature resistance from -45°C to 170°C
- Bend radius to 20mm (AN-06)

Features:

- High flow rate (XF910 & XF811)
- PTFE lined
- Aramid fibre / Stainless steel braided options
- Compatible with crimp & reusable fittings
- SAE J7137 compliant

Fluid applications:

Fuel, Oil, Water, Methanol & Pneumatics

Compatible fittings:

711 crimp fittings
4000 series crimp fittings
811 reusable fittings



The G Line XF 910 is the lightest smoothbore hose in the Goodridge range. The hose features a smooth bore, externally convoluted, carbon impregnated, anti-static PTFE liner, wrapped in a super lightweight Aramid Fibre Braid. In addition to the 711 crimp and 4000 series crimp/draw swage fittings, the G-Line XF 910 hose can be assembled using 811 reusable fittings, without the need for specialist tooling.
 Note: Temperature affects maximum working pressure as listed; for temps above 130° C reduce the working pressure by 0.75% for each degree above 130° C. Max 180°C.
Fluid applications:
 Fuel, Oil, Water, Methanol & Pneumatics
Compatible fittings:
 711 crimp fittings
 4000 series crimp fittings
 811 reusable fittings

Code	Dash No	Bore size mm (in)	Nominal hose OD mm (in)	Working pressure BAR (PSI)	Burst pressure BAR (PSI)	Weight Kg/m (Lb/Ft)	Min. bend radius mm (in)	Temperature range °C (°F)
910-04	-04	6,70 (0,26)	9,70 (0,38)	88 (1276)	350 (5076)	0,070 (0,0471)	20 (0,79)	-40/+180 (-40/+356)
910-06	-06	9,50 (0,37)	13,00 (0,51)	80 (1160)	320 (4641)	0,105 (0,0706)	28 (1,10)	-40/+180 (-40/+356)
910-08	-08	12,70 (0,50)	16,80 (0,66)	70 (1015)	280 (4061)	0,140 (0,0942)	40 (1,57)	-40/+180 (-40/+356)
910-10	-10	15,90 (0,63)	20,90 (0,81)	65 (924)	260 (3770)	0,205 (0,1379)	45 (1,77)	-40/+180 (-40/+356)
910-12	-12	19,00 (0,75)	24,70 (0,97)	60 (870)	240 (3480)	0,214 (0,1440)	55 (2,16)	-40/+180 (-40/+356)
910-16	-16	25,40 (1,00)	32,70 (1,29)	50 (725)	200 (2900)	0,489 (0,3290)	75 (2,95)	-40/+180 (-40/+356)
910-20	-20	31,70 (1,24)	38,60 (1,45)	45 (652)	180 (2610)	0,587 (0,3950)	100 (3,94)	-40/+180 (-40/+356)



The G Line XF 811 is the stainless-steel braided equivalent to the G Line XF 910. The hose features a smooth bore, externally convoluted, carbon impregnated, anti-static PTFE liner, wrapped in a Stainless Steel braid. In addition to the 711 crimp and 4000 series crimp/draw swage fittings, the G-Line XF 811 hose can be assembled using 811 reusable fittings, without the need for specialist tooling.
 Note: Temperature affects maximum working pressure as listed; for temps above 130°C reduce the working pressure by 0.75% for each degree above 130° C. Max 260°C.
Fluid applications:
 Fuel, Oil, Water, Methanol & Pneumatics
Compatible fittings:
 711 crimp fittings
 4000 series crimp fittings
 811 reusable fittings

Code	Dash No	Bore size mm (in)	Nominal hose OD mm (in)	Working pressure BAR (PSI)	Burst pressure BAR (PSI)	Weight Kg/m (Lb/Ft)	Min. bend radius mm (in)	Temperature range °C (°F)
811-04	-04	6,70 (0,26)	9,60 (0,38)	88 (1276)	350 (5076)	0,098 (0,0659)	19 (0,75)	-73/+260 (-99/+500)
811-06	-06	9,50 (0,37)	12,70 (0,50)	80 (1160)	320 (4641)	0,156 (0,1049)	27 (1,06)	-73/+260 (-99/+500)
811-08	-08	12,70 (0,50)	16,40 (0,65)	70 (1015)	280 (4061)	0,233 (0,1568)	38 (1,5)	-73/+260 (-99/+500)
811-10	-10	15,90 (0,63)	20,60 (0,81)	65 (924)	260 (3770)	0,333 (0,2241)	50 (1,97)	-73/+260 (-99/+500)
811-12	-12	19,00 (0,75)	24,20 (0,87)	60 (870)	240 (3480)	0,400 (0,2692)	52 (2,05)	-73/+260 (-99/+500)
811-16	-16	25,40 (1,00)	32,20 (1,27)	50 (725)	200 (2900)	0,660 (0,4158)	70 (2,76)	-73/+260 (-99/+500)



Goodridge 910 FC fuel cell hose is designed for internal fuel cell plumbing and lift pump applications. The hose is smooth bore and externally convoluted, constructed from carbon impregnated PTFE. Available in black (Anti-static) or transparent for inspection purposes. 910 FC is compatible with 4000 series crimp fittings & 711 series crimp fittings (Specialist assembly equipment required). Current customers include teams competing in F1, INDYCAR, WEC, NASCAR, WRC, GT, BTCC, WTCC and club level motorsports.

Fluid applications:
Fuel (Methanol, Alcohol & E-85)

Compatible fittings:
711 crimp fittings
4000 series crimp fittings

Code	Dash No	Bore size mm (in)	Nominal hose OD mm (in)	Working pressure BAR (PSI)	Burst pressure BAR (PSI)	Weight Kg/m (Lb/Ft)	Min. bend radius mm (in)	Temperature range °C (°F)	Note
910-06FC	-06	9,53 (0,38)	13,00 (0,51)	5 (72)	20 (290)	0,06 (0,0403)	60 (2,36)	-45/+50 (-49/+122)	Fuel Cell



G-Flex 711 is the lightest hose in the Goodridge range; used by motorsport teams globally who require the ultimate in weight saving. The G-Flex range features a fully convoluted, carbon impregnated, anti-static PTFE liner, wrapped in an Aramid fibre braid. G-Flex is compatible with 711 crimp fittings and must be assembled using specialist equipment. The G-Flex hose range is a popular choice for motorsport teams looking for the ultimate light weight solution, not requiring the smoothbore flow characteristics of Goodridge G-Line XF & Ultra hoses. Current customers include teams competing in F1, INDYCAR, WEC, NASCAR, WRC, GT, BTCC, WTCC and club level motorsports.

Note: Temperature affects maximum working pressure as listed; for temps above 130°C reduce the working pressure by 0.75% for each degree above 130° C. Max 180° C.

Fluid applications:
Fuel, Oil, Water, Methanol & Pneumatics

Compatible fittings:
711 crimp fittings

Code	Dash No	Bore size mm (in)	Nominal hose OD mm (in)	Working pressure BAR (PSI)	Burst pressure BAR (PSI)	Weight Kg/m (Lb/Ft)	Min. bend radius mm (in)	Temperature range °C (°F)
711-06	-06	9,50 (0,37)	12,45 (0,49)	45 (652)	180 (2610)	0,071 (0,0477)	25 (0,98)	-45/+170 (-49/+338)
711-08	-08	12,84 (12,84)	15,75 (0,62)	34 (493)	136 (1972)	0,112 (0,0753)	30 (1,18)	-45/+170 (-49/+338)
711-10	-10	18,28 (0,72)	20,83 (0,82)	30 (435)	120 (1740)	0,158 (0,1063)	35 (1,38)	-45/+170 (-49/+338)
711-12	-12	19,42 (0,76)	22,75 (0,90)	24 (348)	96 (1392)	0,198 (0,1332)	60 (2,36)	-45/+170 (-49/+338)
711-16	-16	27,00 (1,06)	31,00 (1,22)	20 (290)	80 (1160)	0,298 (0,2005)	89 (3,50)	-45/+170 (-49/+338)



G-Line 710 is a fully convoluted, Aramid fibre braided hose; the most flexible hose in the Goodridge range, compatible with both draw swage and crimp fittings. Similar to the G Flex 711 hose, the G-Line 710 range is fully convoluted, utilising a carbon impregnated, anti-static PTFE liner. G-Line 710 is compatible with 4000 series draw swage fittings (Specialist equipment required). The G-Line 710 range is a popular choice for motorsport teams looking for the tightest bend radius, where high flexibility is required for tight plumbing applications. Current customers include teams competing in F1, INDYCAR, WEC, NASCAR, WRC, GT, BTCC, WTCC and club level motorsports.

Note: Temperature affects maximum working pressure as listed; for temps above 130°C reduce the working pressure by 0.75% for each degree above 130° C. Max 180°C.

Fluid applications:
Fuel, Oil, Water, Methanol & Pneumatics

Compatible fittings:
4000 series crimp/draw swage fittings

Code	Dash No	Bore size mm (in)	Nominal hose OD mm (in)	Working pressure BAR (PSI)	Burst pressure BAR (PSI)	Weight Kg/m (Lb/Ft)	Min. bend radius mm (in)	Temperature range °C (°F)
710-04	-04	7,1 (0,28)	11,3 (0,44)	70 (1015)	280 (4061)	0,075 (0,0504)	19 (0,75)	-40/+180 (-40/+356)
710-06	-06	9,5 (0,37)	14,3 (0,56)	65 (924)	260 (3771)	0,089 (0,0598)	25 (0,98)	-40/+180 (-40/+356)
710-08	-08	12,7 (0,50)	19,2 (0,75)	58 (841)	232 (3365)	0,154 (0,1036)	25 (0,98)	-40/+180 (-40/+356)
710-10	-10	15,2 (0,60)	21,5 (0,85)	50 (725)	200 (2901)	0,164 (0,1103)	32 (1,26)	-40/+180 (-40/+356)
710-12	-12	19,5 (0,77)	25,6 (0,22)	35 (507)	140 (2031)	0,193 (0,1298)	40 (1,57)	-40/+180 (-40/+356)
710-16	-16	25,4 (1,00)	32,8 (1,29)	33 (478)	132 (1915)	0,237 (0,1595)	40 (1,57)	-40/+180 (-40/+356)
710-20	-20	31,8 (1,25)	36,5 (1,44)	25 (362)	100 (1450)	0,461 (0,3102)	75 (2,95)	-40/+180 (-40/+356)

CRIMP FITTINGS

B: Brass - C: Stainless steel - CH: Chrome plated - D: Aluminium - P: Zinc plated carbon steel - Z1: Silver plated carbon steel

711 JIC Fittings for hose
G-Line XF 910 & 811, G-Flex 711



711-01
Straight female concave seat

Code	To suit hose	Thread	Mat
711-0106	-06	9/16 x 18	D
711-0108	-08	3/4 x 16	D
711-0110	-10	7/8 x 14	D
711-0112	-12	1 1/16 x 12	D
711-0116	-16	1 5/16 x 12	D



711-91
90° swept tube female concave seat

Code	To suit hose	Thread	Mat
711-9106	-06	9/16 x 18	D
711-9108	-08	3/4 x 16	D
711-9110	-10	7/8 x 14	D
711-9112	-12	1 1/16 x 12	D
711-9116	-16	1 5/16 x 12	D



711-30
30° swept tube female concave seat

Code	To suit hose	Thread	Mat
711-3006	-06	9/16 x 18	D
711-3008	-08	3/4 x 16	D
711-3010	-10	7/8 x 14	D
711-3012	-12	1 1/16 x 12	D
711-3016	-16	1 5/16 x 12	D



711-120
120° swept tube female concave seat

Code	To suit hose	Thread	Mat
711-12006	-06	9/16 x 18	D
711-12008	-08	3/4 x 16	D
711-12010	-10	7/8 x 14	D
711-12012	-12	1 1/16 x 12	D
711-12016	-16	1 5/16 x 12	D



711-45
45° forged female concave seat

Code	To suit hose	Thread	Mat
711-4506	-06	9/16 x 18	D
711-4508	-08	3/4 x 16	D
711-4510	-10	7/8 x 14	D
711-4512	-12	1 1/16 x 12	D



711-150
150° swept tube female concave seat

Code	To suit hose	Thread	Mat
711-15006	-06	9/16 x 18	D
711-15008	-08	3/4 x 16	D
711-15010	-10	7/8 x 14	D
711-15012	-12	1 1/16 x 12	D
711-15016	-16	1 5/16 x 12	D



711-46
45° swept tube female concave seat

Code	To suit hose	Thread	Mat
711-4606	-06	9/16 x 18	D
711-4608	-08	3/4 x 16	D
711-4610	-10	7/8 x 14	D
711-4612	-12	1 1/16 x 12	D
711-4616	-16	1 5/16 x 12	D



711-180
180° swept tube female concave seat

Code	To suit hose	Thread	Mat
711-18006	-06	9/16 x 18	D
711-18008	-08	3/4 x 16	D
711-18010	-10	7/8 x 14	D
711-18012	-12	1 1/16 x 12	D
711-18016	-16	1 5/16 x 12	D

711 Double Swivel JIC Fittings for hose
G-Line XF 910 & 811, G-Flex 711



711-60
60° swept tube female concave seat

Code	To suit hose	Thread	Mat
711-6006	-06	9/16 x 18	D
711-6008	-08	3/4 x 16	D
711-6010	-10	7/8 x 14	D
711-6012	-12	1 1/16 x 12	D
711-6016	-16	1 5/16 x 12	D



7746
Double swivel tale - 45°swept tube female concave seat

Code	To suit hose	Thread	Mat
7746-06	-06	9/16 x 18	D
7746-08	-08	3/4 x 16	D
7746-10	-10	7/8 x 14	D
7746-12	-12	1 1/16 x 12	D
7746-16	-16	1 5/16 x 12	D



711-90
90° forged female concave seat

Code	To suit hose	Thread	Mat
711-9006	-06	9/16 x 18	D
711-9008	-08	3/4 x 16	D
711-9010	-10	7/8 x 14	D
711-9012	-12	1 1/16 x 12	D



7791
Double swivel tale - 90°swept tube female concave seat

Code	To suit hose	Thread	Mat
7791-06	-06	9/16 x 18	D
7791-08	-08	3/4 x 16	D
7791-10	-10	7/8 x 14	D
7791-12	-12	1 1/16 x 12	D
7791-16	-16	1 5/16 x 12	D

CRIMP FITTINGS

B: Brass - C: Stainless steel - CH: Chrome plated - D: Aluminium - P: Zinc plated carbon steel - Z1: Silver plated carbon steel



77120

Double swivel tale - 120° swept tube female concave seat

Code	To suit hose	Thread	Mat
77120-06	-06	9/16 x 18	D
77120-08	-08	3/4 x 16	D
77120-10	-10	7/8 x 14	D
77120-12	-12	1 1/16 x 12	D
77120-16	-16	1 5/16 x 12	D



77150

150° double swivel

Code	To suit hose	Thread	Mat
77150-06	-06	9/16 x 18	D
77150-08	-08	3/4 x 16	D
77150-10	-10	7/8 x 14	D
77150-12	-12	1 1/16 x 12	D
77150-16	-16	1 5/16 x 12	D



77180

180° double swivel

Code	To suit hose	Thread	Mat
77180-06	-06	9/16 x 18	D
77180-08	-08	3/4 x 16	D
77180-10	-10	7/8 x 14	D
77180-12	-12	1 1/16 x 12	D
77180-16	-16	1 5/16 x 12	D



4000 series JIC Fittings for hoses G-Line XF 910 & 811 (crimp), G-Line 710 (draw swage)



4001

Straight female concave seat

Code	To suit hose	Thread	Mat	Note
4001-04D	-04	7/16 x 20	D	-
4001-04DBK	-04	7/16 x 20	D	Black
4001-06D	-06	9/16 x 18	D	-
4001-08D	-08	3/4 x 16	D	-
4001-10D	-10	7/8 x 14	D	-
4001-12D	-12	1 1/16 x 12	D	-
4001-16D	-16	1 5/16 x 12	D	-
4001-20D	-20	1 5/8 x 12	D	-



4045

45° forged female concave seat

Code	To suit hose	Thread	Mat	Note
4045-04D	-04	7/16 x 20	D	-
4045-04DBK	-04	7/16 x 20	D	Black
4045-06D	-06	9/16 x 18	D	-
4045-08D	-08	3/4 x 16	D	-
4045-10D	-10	7/8 x 14	D	-
4045-12D	-12	1 1/16 x 12	D	-



4046

45° swept tube female concave seat

Code	To suit hose	Thread	Mat	Note
4046-04D	-04	7/16 x 20	D	-
4046-04DBK	-04	7/16 x 20	D	Black
4046-06D	-06	9/16 x 18	D	-
4046-08D	-08	3/4 x 16	D	-
4046-10D	-10	7/8 x 14	D	-
4046-12D	-12	1 1/16 x 12	D	-
4046-16D	-16	1 5/16 x 12	D	-



4090

90° forged female concave seat

Code	To suit hose	Thread	Mat	Note
4090-04D	-04	7/16 x 20	D	-
4090-04DBK	-04	7/16 x 20	D	Black
4090-06D	-06	9/16 x 18	D	-
4090-08D	-08	3/4 x 16	D	-
4090-10D	-10	7/8 x 14	D	-
4090-12D	-12	1 1/16 x 12	D	-



4091

90° swept tube female concave seat

Code	To suit hose	Thread	Mat	Note
4091-04D	-04	7/16 x 20	D	-
4091-04DBK	-04	7/16 x 20	D	Black
4091-06D	-06	9/16 x 18	D	-
4091-08D	-08	3/4 x 16	D	-
4091-10D	-10	7/8 x 14	D	-
4091-12D	-12	1 1/16 x 12	D	-
4091-16D	-16	1 5/16 x 12	D	-



4120

120° swept tube female concave seat

Code	To suit hose	Thread	Mat	Note
4120-04D	-04	7/16 x 20	D	-
4120-04DBK	-04	7/16 x 20	D	Black
4120-06D	-06	9/16 x 18	D	-
4120-08D	-08	3/4 x 16	D	-
4120-10D	-10	7/8 x 14	D	-
4120-12D	-12	1 1/16 x 12	D	-
4120-16D	-16	1 5/16 x 12	D	-



4150

150° swept tube female concave seat

Code	To suit hose	Thread	Mat	Note
4150-04D	-04	7/16 x 20	D	-
4150-06D	-06	9/16 x 18	D	-
4150-08D	-08	3/4 x 16	D	-
4150-10D	-10	7/8 x 14	D	-
4150-12D	-12	1 1/16 x 12	D	-
4150-16D	-16	1 5/16 x 12	D	-



CRIMP FITTINGS

B: Brass - C: Stainless steel - CH: Chrome plated - D: Aluminium - P: Zinc plated carbon steel - Z1: Silver plated carbon steel



4180
180° swept tube female concave seat

Code	To suit hose	Thread	Mat
4180-04D	-04	7/16 x 20	D
4180-06D	-06	9/16 x 18	D
4180-08D	-08	3/4 x 16	D
4180-10D	-10	7/8 x 14	D
4180-12D	-12	1 1/16 x 12	D
4180-16D	-16	1 5/16 x 12	D



4490
90° swivel forged female concave seat

Code	To suit hose	Thread	Mat
4490-04D	-04	7/16 x 20	D
4490-06D	-06	9/16 x 18	D
4490-08D	-08	3/4 x 16	D
4490-10D	-10	7/8 x 14	D
4490-12D	-12	1 1/16 x 12	D



4441
Straight male convex seat

Code	To suit hose	Thread	Mat
4441-04D	-04	7/16 x 20	D
4441-06D	-06	9/16 x 18	D
4441-08D	-08	3/4 x 16	D
4441-10D	-10	7/8 x 14	D

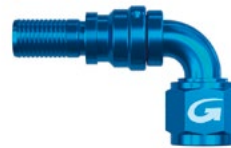

4491
90° swivel swept tube female concave seat

Code	To suit hose	Thread	Mat
4491-04D	-04	7/16 x 20	D
4491-06D	-06	9/16 x 18	D
4491-08D	-08	3/4 x 16	D
4491-10D	-10	7/8 x 14	D
4491-12D	-12	1 1/16 x 12	D
4491-16D	-16	1 5/16 x 12	D



40776
Banjo straight

Code	To suit hose	Thread	Mat
40776-04-M10D	-04	10 mm hole	D
40776-06-M12D	-06	12 mm hole	D
40776-06-M14D	-06	14 mm hole	D
40776-06-M16D	-06	16 mm hole	D



44120
120° swivel swept tube female concave seat

Code	To suit hose	Thread	Mat
44120-04D	-04	7/16 x 20	D
44120-06D	-06	9/16 x 18	D
44120-08D	-08	3/4 x 16	D
44120-10D	-10	7/8 x 14	D
44120-12D	-12	1 1/16 x 12	D
44120-16D	-16	1 5/16 x 12	D

4400 series Double Swivel JIC Fittings for hoses G-Line XF 910 & 811 (crimp), G-Line 710 (draw swage)



4445
45° swivel forged female concave seat

Code	To suit hose	Thread	Mat
4445-04D	-04	7/16 x 20	D
4445-06D	-06	9/16 x 18	D
4445-08D	-08	3/4 x 16	D
4445-10D	-10	7/8 x 14	D
4445-12D	-12	1 1/16 x 12	D



44150
150° swivel swept tube female concave seat

Code	To suit hose	Thread	Mat
44150-04D	-04	7/16 x 20	D
44150-06D	-06	9/16 x 18	D
44150-08D	-08	3/4 x 16	D
44150-10D	-10	7/8 x 14	D
44150-12D	-12	1 1/16 x 12	D



4446
45° swivel swept tube female concave seat

Code	To suit hose	Thread	Mat
4446-04D	-04	7/16 x 20	D
4446-06D	-06	9/16 x 18	D
4446-08D	-08	3/4 x 16	D
4446-10D	-10	7/8 x 14	D
4446-12D	-12	1 1/16 x 12	D
4446-16D	-16	1 5/16 x 12	D



44180
180° swivel swept tube female concave seat

Code	To suit hose	Thread	Mat
44180-04D	-04	7/16 x 20	D
44180-06D	-06	9/16 x 18	D
44180-08D	-08	3/4 x 16	D
44180-10D	-10	7/8 x 14	D
44180-12D	-12	1 1/16 x 12	D

FLEXIBLE COUPLING FITTINGS FOR WIGGINS

B: Brass - C: Stainless steel - CH: Chrome plated - D: Aluminium - P: Zinc plated carbon steel - Z1: Silver plated carbon steel

711 Wiggins/Hydraflow cup Fittings for hose
G-Line XF 910 & 811, G-Flex 711(Made to order)



711-01DFL
Straight to DFL Wiggins/Hydraflow cup

Code	Cup size	Hose/tale size	Mat
711-0108DFL	-08	-08	D
711-0110DFL	-10	-10	D
711-0112DFL	-12	-12	D
711-0116DFL	-16	-16	D



711-180DFL
180° to DFL Wiggins/Hydraflow cup

Code	Cup size	Hose/tale size	Mat
711-18008DFL	-08	-08	D
711-18010DFL	-10	-10	D
711-18012DFL	-12	-12	D
711-18016DFL	-16	-16	D



711-30DFL
30° to DFL Wiggins/Hydraflow cup

Code	Cup size	Hose/tale size	Mat
711-3008DFL	-08	-08	D
711-3010DFL	-10	-10	D
711-3012DFL	-12	-12	D
711-3016DFL	-16	-16	D



4000 series Wiggins/Hydraflow cup fittings
(Made to order)



4001DFL
Straight to DFL Wiggins/Hydraflow cup

Code	Cup size	Hose/tale size	Mat
4001-08-08DFL	-08	-08	D
4001-10-10DFL	-10	-10	D
4001-12-12DFL	-12	-12	D
4001-16-16DFL	-16	-16	D



711-45DFL
45° to DFL Wiggins/Hydraflow cup

Code	Cup size	Hose/tale size	Mat
711-4508DFL	-08	-08	D
711-4510DFL	-10	-10	D
711-4512DFL	-12	-12	D
711-4516DFL	-16	-16	D



4046DFL
45° to DFL Wiggins/Hydraflow cup

Code	Cup size	Hose/tale size	Mat
4046-08-08DFL	-08	-08	D
4046-10-10DFL	-10	-10	D
4046-12-12DFL	-12	-12	D
4046-16-16DFL	-16	-16	D



711-60DFL
60° to DFL Wiggins/Hydraflow cup

Code	Cup size	Hose/tale size	Mat
711-6008DFL	-08	-08	D
711-6010DFL	-10	-10	D
711-6012DFL	-12	-12	D
711-6016DFL	-16	-16	D



4091DFL
90° to DFL Wiggins/Hydraflow cup

Code	Cup size	Hose/tale size	Mat
4091-08-08DFL	-08	-08	D
4091-10-10DFL	-10	-10	D
4091-12-12DFL	-12	-12	D
4091-16-16DFL	-16	-16	D



711-90DFL
90° to DFL Wiggins/Hydraflow cup

Code	Cup size	Hose/tale size	Mat
711-9008DFL	-08	-08	D
711-9010DFL	-10	-10	D
711-9012DFL	-12	-12	D
711-9016DFL	-16	-16	D



4120DFL
120° to DFL Wiggins/Hydraflow cup

Code	Cup size	Hose/tale size	Mat
4120-08-08DFL	-08	-08	D
4120-10-10DFL	-10	-10	D
4120-12-12DFL	-12	-12	D
4120-16-16DFL	-16	-16	D



711-120DFL
120° to DFL Wiggins/Hydraflow cup

Code	Cup size	Hose/tale size	Mat
711-12008DFL	-08	-08	D
711-12010DFL	-10	-10	D
711-12012DFL	-12	-12	D
711-12016DFL	-16	-16	D



4150DFL
150° to DFL Wiggins/Hydraflow cup

Code	Cup size	Hose/tale size	Mat
4150-08-08DFL	-08	-08	D
4150-10-10DFL	-10	-10	D
4150-12-12DFL	-12	-12	D
4150-16-16DFL	-16	-16	D



711-150DFL
150° to DFL Wiggins/Hydraflow cup

Code	Cup size	Hose/tale size	Mat
711-15008DFL	-08	-08	D
711-15010DFL	-10	-10	D
711-15012DFL	-12	-12	D
711-15016DFL	-16	-16	D



4180DFL
180° to DFL Wiggins/Hydraflow cup

Code	Cup size	Hose/tale size	Mat
4180-08-08DFL	-08	-08	D
4180-10-10DFL	-10	-10	D
4180-12-12DFL	-12	-12	D
4180-16-16DFL	-16	-16	D

RE-USABLE FITTINGS

B: Brass - C: Stainless steel - CH: Chrome plated - D: Aluminium - P: Zinc plated carbon steel - Z1: Silver plated carbon steel

811 JIC Fittings for hose
G-LINE XF 910 & 811



811-01
Straight female

Code	To suit hose	Thread	Mat
811-0104	-04	7/16 x 20	D
811-0106	-06	9/16 x 18	D
811-0108	-08	3/4 x 16	D
811-0110	-10	7/8 x 14	D
811-0112	-12	1 1/16 x 12	D
811-0116	-16	1 5/16 x 12	D



811-150
150° swept tube female

Code	To suit hose	Thread	Mat
811-15004	-04	7/16 x 20	D
811-15006	-06	9/16 x 18	D
811-15008	-08	3/4 x 16	D
811-15010	-10	7/8 x 14	D
811-15012	-12	1 1/16 x 12	D
811-15016	-16	1 5/16 x 12	D



812-45
45° forged female

Code	To suit hose	Thread	Mat
812-4506	-06	9/16 x 18	D
812-4508	-08	3/4 x 16	D
812-4510	-10	7/8 x 14	D



811-180
180° swept tube female

Code	To suit hose	Thread	Mat
811-18004	-04	7/16 x 20	D
811-18006	-06	9/16 x 18	D
811-18008	-08	3/4 x 16	D
811-18010	-10	7/8 x 14	D
811-18012	-12	1 1/16 x 12	D
811-18016	-16	1 5/16 x 12	D



811-45
45° swept tube female

Code	To suit hose	Thread	Mat
811-4504	-04	7/16 x 20	D
811-4506	-06	9/16 x 18	D
811-4508	-08	3/4 x 16	D
811-4510	-10	7/8 x 14	D
811-4512	-12	1 1/16 x 12	D
811-4516	-16	1 5/16 x 12	D

OTHER PARTS

Crimp collars for
G-Line hoses



812-90
90° forged female

Code	To suit hose	Thread	Mat
812-9006	-06	9/16 x 18	D
812-9008	-08	3/4 x 16	D
812-9010	-10	7/8 x 14	D
812-9012	-12	1 1/16 x 12	D



RC110
Draw swage collar to suit 4000 series fittings (for use with 710 hose)

Code	Dash	Mat
RC110-04D	-04	D
RC110-06D	-06	D
RC110-08D	-08	D
RC110-10D	-10	D
RC110-12D	-12	D
RC110-16D	-16	D
RC110-20D	-20	D



811-90
90° swept tube female

Code	To suit hose	Thread	Mat
811-9004	-04	7/16 x 20	D
811-9006	-06	9/16 x 18	D
811-9008	-08	3/4 x 16	D
811-9010	-10	7/8 x 14	D
811-9012	-12	1 1/16 x 12	D
811-9016	-16	1 5/16 x 12	D



RCC711
Crimp collar to suit 711 series fittings

Code	Dash	Mat
RCC711-06D	-06	D
RCC711-08D	-08	D
RCC711-10D	-10	D
RCC711-12D	-12	D
RCC711-16D	-16	D



811-120
120° swept tube female

Code	To suit hose	Thread	Mat
811-12004	-04	7/16 x 20	D
811-12006	-06	9/16 x 18	D
811-12008	-08	3/4 x 16	D
811-12010	-10	7/8 x 14	D
811-12012	-12	1 1/16 x 12	D
811-12016	-16	1 5/16 x 12	D



RCC910
Crimp collar to suit 4000 series fittings (for use with 910/811 hose)

Code	Dash	Mat
RCC910-04D	-04	D
RCC910-06D	-06	D
RCC910-08D	-08	D
RCC910-10D	-10	D
RCC910-12D	-12	D
RCC910-16D	-16	D
RCC910-20D	-20	D

The 600 series hose range is a PTFE lined hose, wrapped in a stainless steel braid; designed for brake, clutch, fuel, oil, water, dampers, power steering, gear shift and active differential applications. Available in AN-02 and AN-03.

AN-04, AN-06 & AN-08 bore sizes are available in medium pressure and high pressure variants.

The 700 series hose range is a motorsport use only PTFE lined light weight equivalent to the 600 series, wrapped in an Aramid fibre braid; designed for use with brake, clutch, pressure gauge, fuel injection, fire extinguisher, nitrous & hydraulics. Available in AN-03 and AN-04.

Used by teams competing in F1, INDYCAR, WEC, NASCAR, WRC, GT, BTCC, WTCR and club level motorsports.

Benefits:

- Light weight (700 series)
- Uninterrupted flow
- Burst pressure up to 19580 PSI / 1350 BAR (600-02)
- Temperature resistance from -70°C / -94°F to 260°C / 500°F (600 series)
- Bend radius to 13mm (600-02)

Fitting Type:

600 series = Crimp/reusable
 600MP series = Crimp/reusable
 600HP series = Crimp only
 700 series = Crimp only

Features:

- Smooth bore
- PTFE lined
- Stainless steel braided (600 series) /Aramid fibre braided (700 series)
- Compatible with crimp and reusable fittings (700K series and 600HP are crimp only)



GOODRIDGE
 FLUID TRANSFER SYSTEMS
600 hose series: (AN02 & AN03)

The 600 series hose range is a PTFE lined hose, wrapped in a Stainless-Steel braid; designed for brake and clutch applications. (AN-04, AN-06 & AN-08 600 series hoses and fittings are available in Medium Pressure & High Pressure variants)
 The PTFE liner is braided with Stainless Steel, to provide consistent brake and clutch pedal/lever feel, eliminating any sponginess that may be found with the equivalent rubber hose. There is an option for the Stainless-Steel braid to be wrapped in an abrasive resistant covering that can be wiped clean.
 Compatible with re-usable and crimp fittings. (Specialist equipment required).
 Note: Temperature affects maximum working pressure as listed; for temps above 130° C reduce the working pressure by 0.75% for each degree above 130° C. Max 260°C.
Fluid applications: Brake, Clutch & Hydraulics
Fitting Type: Crimp / Reusable
Compatible fittings: 600 series

Code	Dash No	Bore size mm (in)	Cover	Nominal hose OD mm (in)	Cover outer Ø mm (in)	PTFE wall mm (in)	Cover wall mm (in)	Working pressure BAR (PSI)	Burst pressure BAR (PSI)	Weight Kg/m (Lb/Ft)	Temperature range °C (°F)	Min. bend radius mm (in)
600-02	-02	2,03 (0,080)	Steel (bare)	5,08 (0,200)	-	1 (0,039)	-	450 (6525)	1350 (19580)	0,045 (0,03)	-70/+260 (-94/+500)	13 (0,51)
600-03	-03	3,5 (0,138)	Steel (bare)	6,40 (0,252)	-	1 (0,039)	-	290 (4205)	870 (12618)	0,06 (0,04)	-70/+260 (-94/+500)	38 (1,50)
600-03ABK	-03	3,5 (0,138)	Black	6,40 (0,252)	7,3 (0,287)	1 (0,039)	0,5 (0,019)	290 (4205)	870 (12618)	0,088 (0,0592)	-40/+110 (-40/+230)	38 (1,50)
600-03ACB	-03	3,5 (0,138)	Carbon	6,40 (0,252)	7,3 (0,287)	1 (0,039)	0,5 (0,019)	290 (4205)	870 (12618)	0,088 (0,0592)	-40/+110 (-40/+230)	38 (1,50)
600-03ACL	-03	3,5 (0,138)	Transparent	6,40 (0,252)	7,3 (0,287)	1 (0,039)	0,5 (0,019)	290 (4205)	870 (12618)	0,088 (0,0592)	-40/+110 (-40/+230)	38 (1,50)
600-03AEB	-03	3,5 (0,138)	Electric blue	6,40 (0,252)	7,3 (0,287)	1 (0,039)	0,5 (0,019)	290 (4205)	870 (12618)	0,088 (0,0592)	-40/+110 (-40/+230)	38 (1,50)
600-03AGD	-03	3,5 (0,138)	Gold	6,40 (0,252)	7,3 (0,287)	1 (0,039)	0,5 (0,019)	290 (4205)	870 (12618)	0,088 (0,0592)	-40/+110 (-40/+230)	38 (1,50)
600-03ARD	-03	3,5 (0,138)	Red	6,40 (0,252)	7,3 (0,287)	1 (0,039)	0,5 (0,019)	290 (4205)	870 (12618)	0,088 (0,0592)	-40/+110 (-40/+230)	38 (1,50)



GOODRIDGE
 FLUID TRANSFER SYSTEMS
700K hose series (AN-03)

The 700 series hose range is a PTFE lined light weight equivalent to the 600 series, wrapped in an aramid fibre braid. Motorsport use only.
 Applications include brake, clutch, fuel injection, fire extinguisher, nitrous, pressure gauge & hydraulics.
 The PTFE liner is braided in light weight aramid fibre, providing consistent brake and clutch pedal/lever feel (When used for brake/clutch applications), whilst eliminating any sponginess that may be found with the equivalent rubber hose.
 Compatible with crimp fittings. (Specialist equipment required).
Fluid applications: Brake, Clutch, Pressure Gauge, Fuel Injection, Fire extinguisher, Nitrous & Hydraulics.
Fitting Type: Crimp
Compatible fittings: 600 series

Code	Dash No	Bore size mm (in)	Cover	Nominal hose OD mm (in)	Cover outer Ø mm (in)	PTFE wall mm (in)	Cover wall mm (in)	Working pressure BAR (PSI)	Burst pressure BAR (PSI)	Weight Kg/m (Lb/Ft)	Temperature range °C (°F)	Min. bend radius mm (in)
700K-03	-03	3,5 (0,138)	Aramid fibre	6,7 (0,264)	-	0,95 (0,037)	-	200 (2900)	600 (8702)	0,059 (0,0397)	-40/+180 (-40/+356)	38 (1,50)
700K-03BK	-03	3,5 (0,138)	Black PVC	6,7 (0,264)	7,9 (0,311)	0,95 (0,037)	0,5 (0,019)	200 (2900)	600 (8702)	0,059 (0,0397)	-20/+85 (-4/+185)	38 (1,50)

RE-USABLE FITTINGS

B: Brass - C: Stainless steel - CH: Chrome plated - D: Aluminium - P: Zinc plated carbon steel - Z1: Silver plated carbon steel

600 Series JIC/UNF Re-U-sable Fittings (AN-02, AN-03)



440
Straight male concave seat



Code	To suit hose	Thread	Mat	Note
440-03C	-03	3/8 x 24	C	-
440-03CH	-03	3/8 x 24	CH	-
440-03P	-03	3/8 x 24	P	-



441
Straight male convex seat



Code	To suit hose	Thread	Mat	Note
441-03C	-03	3/8 x 24	C	-
441-03CH	-03	3/8 x 24	CH	-
441-03P	-03	3/8 x 24	P	-



443
Straight male bulkhead



Code	To suit hose	Thread	Mat	Note
443-03C	-03	3/8 x 24	C	-
443-03CH	-03	3/8 x 24	CH	-
443-03P	-03	3/8 x 24	P	-



443BNP
Straight male bulkhead bleed nipple



Code	To suit hose	Thread	Mat	Note
443-03BNP	-03	3/8 x 24	P	Use locknut part no .924



6001
Straight female concave seat



Code	To suit hose	Thread	Mat	Note
6001-02-03C	-02	3/8 x 24	C	for -02 hose
6001-02C	-02	5/16 x 24	C	-
6001-03-04C	-03	7/16 x 20	C	for -03 hose
6001-03C	-03	3/8 x 24	C	-
6001-03D	-03	3/8 x 24	D	-
6001-03P	-03	3/8 x 24	P	-



6046
45° swept tube female concave seat



Code	To suit hose	Thread	Mat	Note
6046-03C	-03	3/8 x 24	C	-
6046-03D	-03	3/8 x 24	D	-
6046-03P	-03	3/8 x 24	P	-



6045
45° forged female concave seat

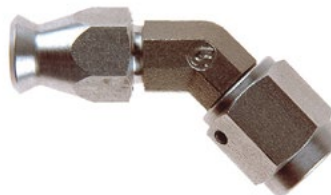

Code	To suit hose	Thread	Mat	Note
6045-02-03C	-02	3/8 x 24	C	for -02 hose
6045-02C	-02	5/16 x 24	C	-
6045-03C	-03	3/8 x 24	C	-
6045-03D	-03	3/8 x 24	D	-



6645
45° forged female double swivel concave seat

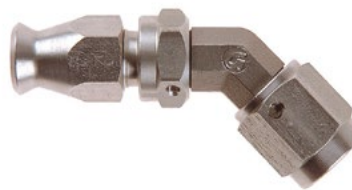

Code	To suit hose	Thread	Mat	Note
6645-03C	-03	3/8 x 24	C	-



6091
90° swept tube female concave seat



Code	To suit hose	Thread	Mat	Note
6091-03C	-03	3/8 x 24	C	-
6091-03CH	-03	3/8 x 24	CH	-
6091-03D	-03	3/8 x 24	D	-
6091-03P	-03	3/8 x 24	P	-



6090
90° forged female concave seat



Code	To suit hose	Thread	Mat	Note
6090-02-03C	-02	3/8 x 24	C	for -02 hose
6090-02C	-02	5/16 x 24	C	-
6090-03C	-03	3/8 x 24	C	-
6090-03D	-03	3/8 x 24	D	-
6090-03P	-03	3/8 x 24	P	-



6690
90° forged female double swivel concave seat

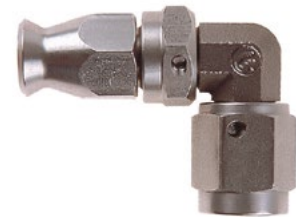

Code	To suit hose	Thread	Mat	Note
6690-03C	-03	3/8 x 24	C	-
6690-03P	-03	3/8 x 24	P	-



704
Fixed female bulkhead convex seat



Code	To suit hose	Thread	Mat	Note
704-03P	-03	7/16 x 20	P	Use locknut part no 2k8686



746
Fixed female bulkhead concave seat



Code	To suit hose	Thread	Mat	Note
746-03P	-03	3/8 x 20BSF (inner)	P	Use locknut part no 2k8686

RE-USABLE FITTINGS

B: Brass - C: Stainless steel - CH: Chrome plated - D: Aluminium - P: Zinc plated carbon steel - Z1: Silver plated carbon steel



Fixed female bulkhead convex seat



Code	To suit hose	Thread	Mat	Note
756-03P	-03	3/8 x 24	P	Use locknut part no 2k8686



Fixed female bulkhead concave seat circlip groove



Code	To suit hose	Thread	Mat	Note
758-03-03P	-03	3/8 x 24	P	-



Fixed female bulkhead convex seat circlip groove



Code	To suit hose	Thread	Mat	Note
759-03-03P	-03	3/8 x 24	P	-

600 Series Metric Re-Usable Fittings (AN-03)



Straight male concave seat



Code	To suit hose	Thread	Mat	Note
442-31C	-03	M10 x 1,00	C	-
442-31CH	-03	M10 x 1,00	CH	-
442-31D	-03	M10 x 1,00	D	-
442-31P	-03	M10 x 1,00	P	-
442-32P	-03	M10 x 1,25	P	-



Straight male concave bulkhead



Code	To suit hose	Thread	Mat	Note
444-31P	-03	M10 x 1,00	P	-



Straight male convex seat



Code	To suit hose	Thread	Mat	Note
445-31C	-03	M10 x 1,00	C	-
445-31CH	-03	M10 x 1,00	CH	-
445-31P	-03	M10 x 1,00	P	-
445-32P	-03	M10 x 1,25	P	-



Convex metric seat bulkhead



Code	To suit hose	Thread	Mat	Note
446-31C	-03	M10 x 1,00	C	-
446-31P	-03	M10 x 1,00	P	-
446-32P	-03	M10 x 1,25	P	-



Straight male flat seat



Code	To suit hose	Thread	Mat	Note
448-31C	-03	M10 x 1,00	C	-
448-31P	-03	M10 x 1,00	P	-



Banjo bolt hose connectors



Code	To suit hose	Thread	Mat	Note
492-31P	-03	M10 x 1,00	P	-



Straight female concave metric seat



Code	To suit hose	Thread	Mat	Note
451-31C	-03	M10 x 1,00	C	-
451-31P	-03	M10 x 1,00	P	-



Straight female convex metric seat



Code	To suit hose	Thread	Mat	Note
452-31C	-03	M10 x 1,00	C	-
452-31P	-03	M10 x 1,00	P	-



Straight fixed female concave metric seat (vw/audi)



Code	To suit hose	Thread	Mat	Note
6001-31CVW	-03	M10 x 1,00	C	VW/Audi
6001-31Z1VW	-03	M10 x 1,00	P	VW/Audi
6001-32Z1VW	-03	M10 x 1,25	Z1	VW/Audi



45° forged female double swivel concave seat

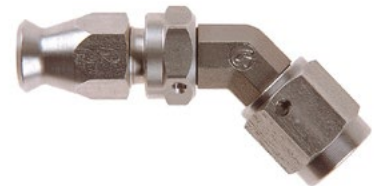

Code	To suit hose	Thread	Mat	Note
6645-31C	-03	M10 x 1,00	C	-



90° forged female double swivel concave seat

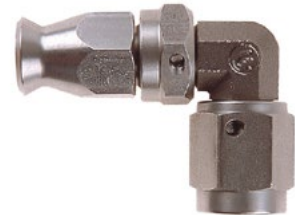

Code	To suit hose	Thread	Mat	Note
6690-31C	-03	M10 x 1,00	C	-



Fixed female bulkhead concave metric seat



Code	To suit hose	Thread	Mat	Note
749-03-31P	-03	M10 x 1,00	P	Use locknut part no 2k8686
749-03-32P	-03	M10 x 1,25	P	Use locknut part no 2k8686

RE-USABLE FITTINGS

B: Brass - C: Stainless steel - CH: Chrome plated - D: Aluminium - P: Zinc plated carbon steel - Z1: Silver plated carbon steel



Fixed female bulkhead convex metric seat



Code	To suit hose	Thread	Mat	Note
750-03-31P	-03	M10 x 1,00	P	Use locknut part no 2k8686
750-03-32P	-03	M10 x 1,25	P	Use locknut part no 2k8686



Fixed female bulkhead convex metric seat w/circlip groove



Code	To suit hose	Thread	Mat	Note
754-03-31P	-03	M10 x 1,00	P	17 mm hex - Subaru



Fixed female bulkhead convex metric seat w/circlip groove

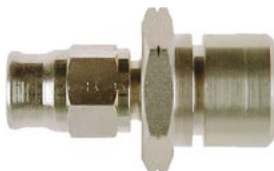

Code	To suit hose	Thread	Mat	Note
755-03-31P	-03	M10 x 1,00	P	19 mm hex



Fixed female bulkhead concave metric seat w/circlip groove



Code	To suit hose	Thread	Mat	Note
756-03-31P	-03	M10 x 1,00	P	19 mm hex



Fixed female bulkhead convex metric seat w/circlip groove



Code	To suit hose	Thread	Mat	Note
757-03-31P	-03	M10 x 1,00	P	17 mm hex - Toyota



Fixed female bulkhead concave metric seat w/circlip groove



Code	To suit hose	Thread	Mat	Note
758-03-31P	-03	M10 x 1,00	P	-
758-03-31SP	-03	M10 x 1,00	P	17 mm hex
758-03-32P	-03	M10 x 1,25	P	-



Fixed female bulkhead convex metric seat w/circlip groove



Code	To suit hose	Thread	Mat	Note
759-03-31P	-03	M10 x 1,00	P	-
759-03-31SP	-03	M10 x 1,00	P	17 mm hex
759-03-32CH	-03	M10 x 1,25	CH	-
759-03-32P	-03	M10 x 1,25	P	-

600 series BSP reusable fittings (AN-03)



Straight female



Code	To suit hose	Thread	Mat	Note
321-03CH	-03	BSP 1/8"	CH	-
321-03P	-03	BSP 1/8"	P	-



Straight female to suit smith pressure gauge



Code	To suit hose	Thread	Mat	Note
321-03SMP	-03	BSP 1/8"	P	Flat face requires gasket



Straight male



Code	To suit hose	Thread	Mat	Note
323-03P	-03	BSP 1/8"	P	-



45° swept tube female



Code	To suit hose	Thread	Mat	Note
331-03P	-03	BSP 1/8"	P	-



90° swept tube female

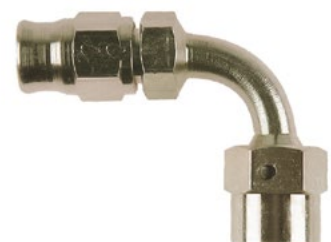

Code	To suit hose	Thread	Mat	Note
332-03P	-03	BSP 1/8"	P	-

RE-USABLE BANJO HOSE FITTINGS

B: Brass - C: Stainless steel - CH: Chrome plated - D: Aluminium - P: Zinc plated carbon steel - Z1: Silver plated carbon steel

600 series banjo reusable fittings (AN-02 & AN-03)



Straight banjo



Code	To suit hose	Hole size	Mat
5091-03-04C	-03	7/16" (11,2 mm)	C
5091-03-04CH	-03	7/16" (11,2 mm)	CH
5091-03-04P	-03	7/16" (11,2 mm)	P
5091-03C	-03	3/8" (10 mm)	C
5091-03D	-03	3/8" (10 mm)	D
5091-03P	-03	3/8" (10 mm)	P



Straight banjo extended neck



Code	To suit hose	Hole size	Mat
5092-02-03C	-02	3/8" (10 mm)	C
5092-02C	-02	5/16" (8 mm)	C
5092-03-02C	-03	5/16" (8 mm)	C
5092-03-02P	-03	5/16" (8 mm)	P
5092-03-04C	-03	7/16" (11,2 mm)	C
5092-03-04P	-03	7/16" (11,2 mm)	P
5092-03C	-03	3/8" (10 mm)	C
5092-03CH	-03	3/8" (10 mm)	CH
5092-03D	-03	3/8" (10 mm)	D
5092-03-M12C	-03	12 mm	C
5092-03-M12CH	-03	12 mm	CH
5092-03-M12P	-03	12 mm	P
5092-03P	-03	3/8" (10 mm)	P



20° banjo extended neck



Code	To suit hose	Hole size	Mat
5093-02-03C	-02	3/8" (10 mm)	C
5093-02C	-02	5/16" (8 mm)	C
5093-03-04C	-03	7/16" (11,2 mm)	C
5093-03-04P	-03	7/16" (11,2 mm)	P
5093-03C	-03	3/8" (10 mm)	C
5093-03D	-03	3/8" (10 mm)	D
5093-03-M12C	-03	3/8" (10 mm)	C
5093-03-M12CH	-03	3/8" (10 mm)	CH
5093-03P	-03	3/8" (10 mm)	P



20° banjo side extended neck



Code	To suit hose	Hole size	Mat
5097-03C	-03	3/8" (10 mm)	C
5097-03CH	-03	3/8" (10 mm)	CH
5097-03D	-03	3/8" (10 mm)	D
5097-03P	-03	3/8" (10 mm)	P



45° banjo extended neck



Code	To suit hose	Hole size	Mat
5094-02-03C	-02	3/8" (10 mm)	C
5094-03C	-03	3/8" (10 mm)	C
5094-03CH	-03	3/8" (10 mm)	CH
5094-03D	-03	3/8" (10 mm)	D
5094-03P	-03	3/8" (10 mm)	P



70° banjo extended neck



Code	To suit hose	Hole size	Mat
5070-03C	-03	3/8" (10 mm)	C
5070-03P	-03	3/8" (10 mm)	P



90° banjo extended neck



Code	To suit hose	Hole size	Mat
5099-03-04C	-03	7/16" (11,2 mm)	C
5099-03-04CH	-03	7/16" (11,2 mm)	CH
5099-03C	-03	3/8" (10 mm)	C
5099-03CH	-03	3/8" (10 mm)	CH
5099-03D	-03	3/8" (10 mm)	D
5099-03P	-03	3/8" (10 mm)	P



90° banjo side extended neck



Code	To suit hose	Hole size	Mat
5099S-03C	-03	3/8" (10 mm)	C
5099S-03P	-03	3/8" (10 mm)	P



Straight twin banjo



Code	To suit hose	Hole size	Mat
5095-03C	-03	3/8" (10 mm)	C
5095-03P	-03	3/8" (10 mm)	P



Banjo twin extended neck



Code	To suit hose	Hole size	Mat
5098-03C	-03	3/8" (10 mm)	C
5098-03P	-03	3/8" (10 mm)	P



90° Double banjo



Code	To suit hose	Hole size	Mat
5096-03C	-03	3/8" (10 mm)	C

RE-USABLE TEE HOSE FITTINGS

B: Brass - C: Stainless steel - CH: Chrome plated - D: Aluminium - P: Zinc plated carbon steel - Z1: Silver plated carbon steel

600 series reusable T fittings (AN-02 & AN-03)



Tee fitting JIC/UNF with locating lug



Code	To suit hose	Thread	Mat
5130-03C	-03	3/8 x 24	C



Tee fitting with male JIC/UNF lug



Code	To suit hose	Thread	Mat
5132-03C	-03	3/8 x 24	C



Tee hose fitting



Code	To suit hose	Thread	Mat
5135-02C	-02	-	C
5135-03C	-03	-	C
5135-03D	-03	-	D



Tee hose fitting with locating lug



Code	To suit hose	Thread	Mat
5136-03C	-03	-	C



Tee Hose fitting with M10 female



Code	To suit hose	Thread	Mat
5140-03C	-03	A = 3/8x24 - B = M10	C



Female 3-way fitting - JIC/UNF or Metric



Code	To suit hose	Thread	Mat
2203-03B	-03	3/8 x 24	B
319-31B	-03	M10 x 1,00	B



Female 4-way fitting - JIC/UNF or Metric



Code	To suit hose	Thread	Mat
2204-03B	-03	3/8 x 24	B
2204-31B	-03	M10 x 1,00	B

Replacement olives and sockets for 600 series reusable fittings (AN-02 & AN-03)



Replacement olive for 600 hose



Code	Mat	To suit
1205-02B	B	-02
1205-03B	B	-03
1205-03C	C	-03
1205-03D	D	-03



Replacement socket for 600 hose



Code	Mat	To suit
1206-02C	C	-02
1206-03C	C	-03
1206-03CH	CH	-03
1206-03D	D	-03
1206-03P	P	-03



CRIMP FITTINGS

B: Brass - C: Stainless steel - CH: Chrome plated - D: Aluminium - P: Zinc plated carbon steel - Z1: Silver plated carbon steel

600 series JIC/UNF crimp fittings (AN-02 & AN-03)



S440
Straight male concave seat



Code	To suit hose	Thread	Mat	Note
S440-03Z1	-03	3/8 x 24	Z1	-



S441
Straight male convex seat



Code	To suit hose	Thread	Mat	Note
S441-03C	-03	3/8 x 24	C	-
S441-03Z1	-03	3/8 x 24	Z1	-



S443
Straight male bulkhead convex seat



Code	To suit hose	Thread	Mat	Note
S443-03BNZ1	-03	3/8 x 24	Z1	integral bleed nipple - use locknut 924-03
S443-03C	-03	3/8 x 24	C	use locknut 924-03
S443-03Z1	-03	3/8 x 24	Z1	use locknut 924-03



S449
Straight male flat seat



Code	To suit hose	Thread	Mat	Note
S449-03Z1	-03	3/8 x 24	Z1	-



S6001
Straight female concave seat



Code	To suit hose	Thread	Mat	Note
S6001-02-03C	-02	3/8 x 24	C	-
S6001-02C	-02	5/16 x 24	C	-
S6001-03-04C	-03	7/16 x 20	C	-
S6001-03C	-03	3/8 x 24	C	-
S6001-03CBK	-03	3/8 x 24	C	Black
S6001-03D	-03	3/8 x 24	D	-
S6001-03DBK	-03	3/8 x 24	D	Black
S6001-03Z1	-03	3/8 x 24	Z1	-



S6046
45° swept tube female concave seat



Code	To suit hose	Thread	Mat	Note
S6046-03C	-03	3/8 x 24	C	-
S6046-03D	-03	3/8 x 24	D	-
S6046-03DBK	-03	3/8 x 24	D	Black
S6046-03Z1	-03	3/8 x 24	Z1	-



S6045
45° forged female concave seat

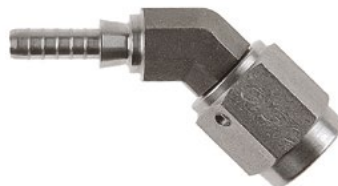

Code	To suit hose	Thread	Mat	Note
S6045-02C	-02	5/16 x 24	C	-
S6045-03C	-03	3/8 x 24	C	-
S6045-03D	-03	3/8 x 24	D	-



S6645
45° forged female double swivel caliper fitting



Code	To suit hose	Thread	Mat	Note
S6645-03CK	-03	3/8 x 24	C	FFKM o-ring
S6645-03CV	-03	3/8 x 24	C	VITON o-ring



S6091
90° swept tube female concave seat



Code	To suit hose	Thread	Mat	Note
S6091-02-03C	-02	3/8 x 24	C	-
S6091-03-04P	-03	7/16 x 20	P	-
S6091-03C	-03	3/8 x 24	C	-
S6091-03D	-03	3/8 x 24	D	-
S6091-03DBK	-03	3/8 x 24	D	Black
S6091-03Z1	-03	3/8 x 24	Z1	-



S6090
90° forged female concave seat



Code	To suit hose	Thread	Mat	Note
S6090-02-03C	-02	3/8 x 24	C	-
S6090-02C	-02	5/16 x 24	C	-
S6090-03-02C	-03	5/16 x 24	C	-
S6090-03C	-03	3/8 x 24	C	-
S6090-03D	-03	3/8 x 24	D	-
S6090-03Z1	-03	3/8 x 24	Z1	-



S6690
90° forged female double swivel caliper fitting



Code	To suit hose	Thread	Mat	Note
S6690-03CK	-03	3/8 x 24	C	FFKM o-ring



S747
Fixed female convex seat w/circlip groove 17mm hex



Code	To suit hose	Thread	Mat	Note
S747-03Z1	-03	3/8 x 24	Z1	-

CRIMP FITTINGS

B: Brass - C: Stainless steel - CH: Chrome plated - D: Aluminium - P: Zinc plated carbon steel - Z1: Silver plated carbon steel



Straight female JIC concave seat with circlip groove



Code	To suit hose	Thread	Mat	Note
S758-03-03Z1	-03	3/8 x 24	Z1	-



Fixed female bulkhead concave seat



Code	To suit hose	Thread	Mat	Note
S748-03Z1	-03	3/8 x 24	Z1	-
S748-03Z1DS	-03	3/8 x 24	Z1	MINI 91 ON - use locknut 2k8686



Fixed female bulkhead convex seat



Code	To suit hose	Thread	Mat	Note
S756-03Z1	-03	3/8 x 24	Z1	-



Straight female convex seat w/circlip groove



Code	To suit hose	Thread	Mat	Note
S759-03-03S21	-03	3/8 x 24	Z1	17 mm hex
S759-03-03Z1	-03	3/8 x 24	Z1	-
S759-03-44Z1	-03	7/16 x 24	Z1	-

600 series metric crimp fittings (AN-03)



Straight male concave seat



Code	To suit hose	Thread	Mat	Note
S442-31C	-03	M10 x 1,00	C	-
S442-31LZ1	-03	M10 x 1,00	Z1	Long
S442-31Z1	-03	M10 x 1,00	Z1	-



Straight male concave bulkhead



Code	To suit hose	Thread	Mat	Note
S444-31Z1	-03	M10 x 1,00	Z1	-



Straight male dual seat



Code	To suit hose	Thread	Mat	Note
S445-03-M121C	-03	M12 x 1,00	C	-
S445-31C	-03	M10 x 1,00	C	-
S445-31Z1	-03	M10 x 1,00	Z1	-
S445-32Z1	-03	M10 x 1,25	Z1	-



Straight male swivel - metric dual seat



Code	To suit hose	Thread	Mat	Note
S445-0131C	-03	M10 x 1,00	C	-
S445-0131Z1	-03	M10 x 1,00	Z1	-
S445-0132C	-03	M10 x 1,25	C	-
S445-0132Z1	-03	M10 x 1,25	Z1	-



Straight male bulkhead



Code	To suit hose	Thread	Mat	Note
S446-03-M121LP	-03	M12 x 1,00	P	Long
S446-03-M121Z	-03	M12 x 1,00	Z1	-
S446-31C	-03	M10 x 1,00	C	use locknut 318-31
S446-31Z1	-03	M10 x 1,00	Z1	use locknut 318-31



Banjo bolt connector



Code	To suit hose	Thread	Mat	Note
S492-31Z1	-03	M10 x 1,00	Z1	-



20° male swivel metric dual seat



Code	To suit hose	Thread	Mat	Note
S445-2031C	-03	M10 x 1,00	C	-
S445-2031Z1	-03	M10 x 1,00	Z1	-



45° male swivel metric dual seat



Code	To suit hose	Thread	Mat	Note
S445-4531C	-03	M10 x 1,00	C	-
S445-4531Z1	-03	M10 x 1,00	Z1	-



90° male swivel - metric dual seat



Code	To suit hose	Thread	Mat	Note
S445-9031C	-03	M10 x 1,00	C	-
S445-9031Z1	-03	M10 x 1,00	Z1	-
S445-90M121C	-03	M12 x 1,00	C	-

CRIMP FITTINGS

B: Brass - C: Stainless steel - CH: Chrome plated - D: Aluminium - P: Zinc plated carbon steel - Z1: Silver plated carbon steel



90° male swivel caliper fitting



Code	To suit hose	Thread	Mat	Note
S6090M-31CSW	-03	M10 x 1,00	C	High temp o-ring
S6090M-31CSW-LT	-03	M10 x 1,00	C	EPDM o-ring



Female concave swivel



Code	To suit hose	Thread	Mat	Note
S451-31C	-03	M10 x 1,00	C	-
S451-31Z1	-03	M10 x 1,00	Z1	-



Female convex swivel



Code	To suit hose	Thread	Mat	Note
S452-31C	-03	M10 x 1,00	C	-
S452-31Z1	-03	M10 x 1,00	Z1	-



90° forged female concave seat

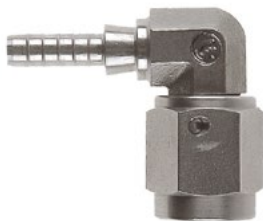

Code	To suit hose	Thread	Mat	Note
S6090-31C	-03	M10 x 1,00	C	-



Fixed female bulkhead concave metric seat



Code	To suit hose	Thread	Mat	Note
S749-03-31C	-03	M10 x 1,00	C	use locknut 2K8686
S749-03-31Z1	-03	M10 x 1,00	Z1	use locknut 2K8686
S749-03-32Z1	-03	M10 x 1,25	Z1	use locknut 2K8686



Fixed female bulkhead convex metric seat



Code	To suit hose	Thread	Mat	Note
S750-03-31Z1	-03	M10 x 1,00	Z1	use locknut 2k8686



Straight female concave seat



Code	To suit hose	Thread	Mat	Note
S6001-31CAU	-03	M10 x 1,00	C	AUDI
S6001-31CMN	-03	M10 x 1,00	C	BMW/MINI
S6001-31CVW	-03	M10 x 1,00	C	VW
S6001-31CVWG7	-03	M10 x 1,00	C	VW G7
S6001-31Z1AU	-03	M10 x 1,00	Z1	AUDI
S6001-31Z1LR	-03	M10 x 1,00	Z1	Land Rover
S6001-31Z1MN	-03	M10 x 1,00	Z1	BMW/MINI
S6001-31Z1PR	-03	M10 x 1,00	Z1	PEUGEOT
S6001-31Z1VW	-03	M10 x 1,00	Z1	VW
S6001-31Z1VWG7	-03	M10 x 1,00	Z1	VWG7



Fixed female bulkhead convex metric seat w/circlip groove



Code	To suit hose	Thread	Mat	Note
S754-03-31C	-03	M10 x 1,00	C	17 mm hex - Subaru
S754-03-31Z1	-03	M10 x 1,00	Z1	17 mm hex - Subaru



Straight female convex metric seat w/circlip groove



Code	To suit hose	Thread	Mat	Note
S755-03-31Z1	-03	M10 x 1,00	Z1	Toyota



Straight female concave seat w/circlip groove



Code	To suit hose	Thread	Mat	Note
S756-03-M121C	-03	M12 x 1,00	C	-



Straight female convex metric seat w/circlip groove



Code	To suit hose	Thread	Mat	Note
S757-03-31C	-03	M10 x 1,00	C	17 mm hex - Subaru
S757-03-31Z1	-03	M10 x 1,00	Z1	17 mm rounded edges hex
S757-03-31Z1DS	-03	M10 x 1,00	Z1	17 mm hex, deep seat
S757-03-31Z1E	-03	M10 x 1,00	Z1	17 mm hex, extended



Straight female metric concave seat w/circlip groove



Code	To suit hose	Thread	Mat	Note
S758-03-31C	-03	M10 x 1,00	C	-
S758-03-31SC	-03	M10 x 1,00	C	17 mm hex
S758-03-31SFC	-03	M10 x 1,00	C	17 mm hex, flat face
S758-03-31SFZ1	-03	M10 x 1,00	Z1	17 mm hex, flat face
S758-03-31SZ1	-03	M10 x 1,00	Z1	17 mm hex
S758-03-31Z1	-03	M10 x 1,00	Z1	-

CRIMP FITTINGS

B: Brass - C: Stainless steel - CH: Chrome plated - D: Aluminium - P: Zinc plated carbon steel - Z1: Silver plated carbon steel



Straight female convex seat w/circlip groove



Code	To suit hose	Thread	Mat	Note
S759-03-31C	-03	M10 x 1,00	C	-
S759-03-31FBZ1	-03	M10 x 1,00	Z1	Flat face
S759-03-31FZ1	-03	M10 x 1,00	Z1	Flat hex
S759-03-31SC	-03	M10 x 1,00	C	17 mm hex
S759-03-31SZ1	-03	M10 x 1,00	Z1	17 mm hex
S759-03-31Z1	-03	M10 x 1,00	Z1	-
S759-03-31Z1BKT	-03	M10 x 1,00	Z1	With bracket
S759-03-32Z1	-03	M10 x 1,25	Z1	-
S759-03-35SC	-03	M10 x 1,50	C	17mm hex
S759-03-35SZ1	-03	M10 x 1,50	Z1	17mm hex
S759-03-M121Z1	-03	M12 x 1,00	Z1	-
S759-9131C	-03	M10 x 1,00	C	-
S759-9131Z1	-03	M10 x 1,00	Z1	-



Crimp fittings - straight female locator convex seat



Code	To suit hose	Thread	Mat	Note
S760-03-31Z1	-03	M10 x 1,00	Z1	Toyota



Straight female (rounded edge) convex seat w/circlip groove



Code	To suit hose	Thread	Mat	Note
S762-03-31SZ1	-03	M10 x 1,00	Z1	17 mm hex - Mazda
S762-03-31Z1	-03	M10 x 1,00	Z1	-



Straight female convex seat w/circlip groove



Code	To suit hose	Thread	Mat	Note
S767-03-31C	-03	M10 x 1,00	C	-
S767-03-31Z1	-03	M10 x 1,00	Z1	-



Straight female concave w/circlip groove



Code	To suit hose	Thread	Mat	Note
S768-03-31SZ1	-03	M10 x 1,00	Z1	17mm hex



Straight male convex seat



Code	To suit hose	Thread	Mat	Note
S770-03Z1	-03	M10 x 1,00	Z1	FORD



Straight male convex seat metric w/locating flat



Code	To suit hose	Thread	Mat	Note
S771-03Z1	-03	M10 x 1,00	Z1	FORD



Straight male concave seat



Code	To suit hose	Thread	Mat	Note
S772-03Z1	-03	M10 x 1,00	Z1	FORD



Straight male bulkhead convex seat



Code	To suit hose	Thread	Mat	Note
S446-31EXC	-03	M10 x 1,00	C	VW Golf/BMW
S446-31EXZ1	-03	M10 x 1,00	Z1	VW Golf/BMW

600 series BSP/NPT crimp fittings (AN-03)



Straight male concave seat



Code	To suit hose	Thread	Mat	Note
S323-03Z1	-03	1/8" BSP	Z1	-



Straight female BSP



Code	To suit hose	Thread	Mat	Note
S321-03SMZ1	-03	1/8" BSP	Z1	Flat seat
S321-03Z1	-03	1/8" BSP	Z1	Convex seat



90° swept tube female BSP



Code	To suit hose	Thread	Mat	Note
S332-03Z1	-03	1/8" BSP	Z1	-



Straight male NPT



Code	To suit hose	Thread	Mat	Note
INS-318DZ	-03	NPT 1/8"	B	-

CRIMP TEE'S

B: Brass - C: Stainless steel - CH: Chrome plated - D: Aluminium - P: Zinc plated carbon steel - Z1: Silver plated carbon steel



Tee with locating lug



Code	Spur	On the run	Mat	Note
S5132-03-03C	-03	3/8 x 24	C	-



3 way tee with locating lug

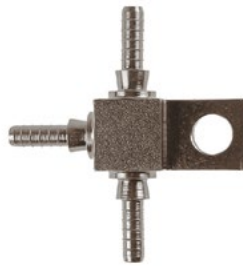

Code	Spur	On the run	Mat	Note
S5136-03C	-03	-03	C	-
S5136-03Z1	-03	-03	Z1	Lug 16mm thick



90° block



Code	Spur	On the run	Mat	Note
S5236-03Z1	-03	-03	Z1	-



3 way tee



Code	Spur	On the run	Mat	Note
S5135-03C	-03	-03	C	-
S5135-03SC	-03	-03	C	Slimline
S5135-03Z1	-03	-03	Z1	-



90° compact elbow



Code	Spur	On the run	Mat	Note
S5139-03SC	-03	-03	C	-

CRIMP BANJOS



Banjo



Code	To suit hose	Hole size	Mat	Note
S5091-02-03C	-02	3/8" (10 mm)	C	-
S5091-03-04Z1	-03	7/16" (11,2 mm)	Z1	-
S5091-03C	-03	3/8" (10 mm)	C	-
S5091-03CBK	-03	3/8" (10 mm)	C	Black
S5091-03-M12C	-03	12 mm	C	-
S5091-03-M12Z1	-03	12 mm	Z1	-
S5091-03SD	-03	3/8" (10 mm)	D	8 mm thick
S5091-03Z1	-03	3/8" (10 mm)	Z1	-



Straight banjo extended neck



Code	To suit hose	Hole size	Mat	Note
S5092-03-02C	-03	5/16"	C	-
S5092-03-04C	-03	7/16" (11,2 mm)	C	-
S5092-03-04CH	-03	7/16" (11,2 mm)	CH	-
S5092-03-04Z1	-03	7/16" (11,2 mm)	Z1	-
S5092-03C	-03	3/8" (10 mm)	C	-
S5092-03CBK	-03	3/8" (10 mm)	C	Black
S5092-03CH	-03	3/8" (10 mm)	CH	-
S5092-03D	-03	3/8" (10 mm)	D	-
S5092-03DBK	-03	3/8" (10 mm)	D	Black
S5092-03DRD	-03	3/8" (10 mm)	D	Red
S5092-03-M12C	-03	12 mm	C	-
S5092-03-M12CH	-03	12 mm	CH	-
S5092-03Z1	-03	3/8" (10 mm)	Z1	-



20° banjo extended neck



Code	To suit hose	Hole size	Mat	Note
S5093-02-03C	-02	3/8" (10 mm)	C	-
S5093-03-02C	-03	5/16"	C	-
S5093-03-04C	-03	7/16" (11,2 mm)	C	-
S5093-03-04CH	-03	7/16" (11,2 mm)	CH	-
S5093-03-04Z1	-03	7/16" (11,2 mm)	Z1	-
S5093-03C	-03	3/8" (10 mm)	C	-
S5093-03CBK	-03	3/8" (10 mm)	C	Black
S5093-03D	-03	3/8" (10 mm)	D	-
S5093-03DBK	-03	3/8" (10 mm)	D	Black
S5093-03DRD	-03	3/8" (10 mm)	D	Red
S5093-03-M12C	-03	12 mm	C	-
S5093-03Z1	-03	3/8" (10 mm)	Z1	-

CRIMP BANJOS

B: Brass - C: Stainless steel - CH: Chrome plated - D: Aluminium - P: Zinc plated carbon steel - Z1: Silver plated carbon steel



20°/20° banjo compound left



Code	To suit hose	Hole size	Mat	Note
S5093L-03C	-03	3/8" (10 mm)	C	-
S5093L-03CBK	-03	3/8" (10 mm)	C	Black
S5093L-03Z1	-03	3/8" (10 mm)	Z1	-



45°/45° banjo compound left



Code	To suit hose	Hole size	Mat	Note
S5094L-03C	-03	3/8" (10 mm)	C	-
S5094L-03CBK	-03	3/8" (10 mm)	C	Black
S5094L-03Z1	-03	3/8" (10 mm)	Z1	-



90° banjo extended neck side bend



Code	To suit hose	Hole size	Mat	Note
S5099S-03C	-03	3/8" (10 mm)	C	-
S5099S-03CBK	-03	3/8" (10 mm)	C	Black
S5099S-03-M6C	-03	6 mm	C	Black
S5099S-03Z1	-03	3/8" (10 mm)	Z1	-
S5099SL-03C	-03	3/8" (10 mm)	C	45° L/hand thread
S5099SL-03CBK	-03	3/8" (10 mm)	C	45° L/hand thread - black
S5099SL2-03C	-03	3/8" (10 mm)	C	20° L/hand thread
S5099SL2-03CBK	-03	3/8" (10 mm)	C	20° L/hand thread - black
S5099SR-03C	-03	3/8" (10 mm)	C	45° R/hand thread
S5099SR-03CBK	-03	3/8" (10 mm)	C	45° R/hand thread - black



20°/20° banjo compound right



Code	To suit hose	Hole size	Mat	Note
S5093R-03C	-03	3/8" (10 mm)	C	-
S5093R-03CBK	-03	3/8" (10 mm)	C	Black
S5093R-03Z1	-03	3/8" (10 mm)	Z1	-



45°/45° banjo compound right



Code	To suit hose	Hole size	Mat	Note
S5094R-03C	-03	3/8" (10 mm)	C	-
S5094R-03CBK	-03	3/8" (10 mm)	C	Black
S5094R-03Z1	-03	3/8" (10 mm)	Z1	-



20° side banjo extended neck



Code	To suit hose	Hole size	Mat	Note
S5097-03-02C	-03	5/16"	C	-
S5097-03C	-03	3/8" (10 mm)	C	-
S5097-03CBK	-03	3/8" (10 mm)	C	Black
S5097-03CH	-03	3/8" (10 mm)	CH	-
S5097-03D	-03	3/8" (10 mm)	D	-
S5097-03DBK	-03	3/8" (10 mm)	D	Black
S5097-03DRD	-03	3/8" (10 mm)	D	Red
S5097-03Z1	-03	3/8" (10 mm)	Z1	-



70° banjo extended neck



Code	To suit hose	Hole size	Mat	Note
S5070-03C	-03	3/8" (10 mm)	C	-
S5070-03CBK	-03	3/8" (10 mm)	C	Black
S5070-03CH	-03	3/8" (10 mm)	CH	-
S5070-03Z1	-03	3/8" (10 mm)	Z1	-



Banjo double tail



Code	To suit hose	Hole size	Mat	Note
S5095-03C	-03	3/8" (10 mm)	C	-
S5095-03CBK	-03	3/8" (10 mm)	C	Black
S5095-03Z1	-03	3/8" (10 mm)	Z1	-



45° banjo extended neck



Code	To suit hose	Hole size	Mat	Note
S5094-03-02C	-03	5/16"	C	-
S5094-03C	-03	3/8" (10 mm)	C	-
S5094-03CBK	-03	3/8" (10 mm)	C	Black
S5094-03CH	-03	3/8" (10 mm)	CH	-
S5094-03D	-03	3/8" (10 mm)	D	-
S5094-03DBK	-03	3/8" (10 mm)	D	Black
S5094-03DRD	-03	3/8" (10 mm)	D	Red
S5094-03Z1	-03	3/8" (10 mm)	Z1	-



90° side banjo extended neck



Code	To suit hose	Hole size	Mat	Note
S5099-03-02C	-03	5/16"	C	-
S5099-03-04CH	-03	7/16"	CH	-
S5099-03C	-03	3/8" (10 mm)	C	-
S5099-03CBK	-03	3/8" (10 mm)	C	Black
S5099-03CH	-03	3/8" (10 mm)	CH	-
S5099-03D	-03	3/8" (10 mm)	D	-
S5099-03DBK	-03	3/8" (10 mm)	D	Black
S5099-03DRD	-03	3/8" (10 mm)	D	Red
S5099-03Z1	-03	3/8" (10 mm)	Z1	-



Banjo twin tail extended neck



Code	To suit hose	Hole size	Mat	Note
S5098-03P	-03	3/8" (10 mm)	P	-

CRIMP COLLARS



Crimp collar



Code	To suit	Mat
RC600-02CMP	-02	C
RC600-03CTUV	-03	C
RC600-03TUV	-03	B

LOCATING TAB

B: Brass - C: Stainless steel - CH: Chrome plated - D: Aluminium - P: Zinc plated carbon steel - Z1: Silver plated carbon steel



Line locator with 17mm hex, one rounded corner



Code	Application	To suit	Mat	Note
BTL-300Z1	Mazda, Mitsubishi	600-03	Z1	17 mm hex with one rounded corner
BTL-310Z1	Mazda, Mitsubishi	600-03 covered	Z1	-



Line locator 19mm hex with silicone insert



Code	Application	To suit	Mat	Note
BTL-305Z1	Mazda	600-03	Z1	-
BTL-315Z1	Mazda	600-03 covered	Z1	-



Single locating tab



Code	Application	To suit	Mat
BLT-301NY	Honda, Acura, Rover, MG	600-03	Nylon
BLT-311NY	Honda, Acura, Rover, MG	600-03 covered	Nylon



Line locator



Code	Application	To suit	Mat	Note
BTL-322Z1	VW Golf MK5	600-03 covered	Z1	-



Line locator 19mm hex with silicone insert

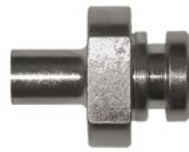

Code	Application	To suit	Mat	Note
BTL-306Z1	Subaru	600-03	Z1	-
BTL-316Z1	Subaru	600-03 covered	Z1	-



Double locating tab



Code	Application	To suit	Mat
BLT-302NY	Honda, Acura, Rover, MG	600-03	Nylon
BLT-312NY	Honda, Acura, Rover, MG	600-03 covered	Nylon



Single locating tab



Code	Application	To suit	Mat	Note
BTL-303Z1	Toyota	600-03	Z1	-
BTL-313Z1	Toyota	600-03 covered	Z1	-



Line locator 17 mm hex with opposite rounded corners



Code	Application	To suit	Mat	Note
BTL-307Z1	Toyota	600-03	Z1	-
BTL-317Z1	Toyota	600-03 covered	Z1	-



Line locator 19mm hex with silicone insert



Code	Application	To suit	Mat	Note
BTL-304Z1	Nissan, GM	600-03	Z1	-
BTL-314Z1	Nissan, GM	600-03 covered	Z1	-



Line locator 17mm hex with 10mm clip groove



Code	Application	To suit	Mat	Note
BTL-308Z1	Subaru	600-03	Z1	-
BTL-318Z1	Subaru	600-03 covered	Z1	-



BANJO BOLTS

B: Brass - C: Stainless steel - CH: Chrome plated - D: Aluminium - P: Zinc plated carbon steel - Z1: Silver plated carbon steel



Single banjo bolt JIC



Code	Thread	Mat	Note
775-02C	5/16 x 24	C	-
775-03-02Z1	5/16 x 24	Z1	For banjo -03
775-03C	3/8 x 24	C	-
775-03CBK	3/8 x 24	C	Black
775-03CH	3/8 x 24	CH	-
775-03D	3/8 x 24	D	Red
775-03DBK	3/8 x 24	D	Black
775-03LC	3/8 x 24	C	Long (25 mm under hex)
775-03LZ1	3/8 x 24	Z1	Long (25 mm under hex)
775-03Z1	3/8 x 24	Z1	-



Single banjo bolt BSP



Code	Thread	Mat	Note
1012-03P	BSP 1/8"	P	-



Double banjo bolt metric



Code	Thread	Mat	Note
993-03-31C	M10 x 1,00	C	-
993-03-31CH	M10 x 1,00	CH	-
993-03-31D	M10 x 1,00	D	Red
993-03-31DBK	M10 x 1,00	D	Black
993-03-31DBU	M10 x 1,00	D	Blue
993-03-31LZ1	M10 x 1,00	Z1	Long (40 mm under hex)
993-03-31SC	M10 x 1,00	C	Short (28 mm under hex)
993-03-31SCBK	M10 x 1,00	C	Short black(28 mm under hex)
993-03-31SZ1	M10 x 1,00	Z1	Short (28 mm under hex)
993-03-31Z1	M10 x 1,00	Z1	-
993-03-32C	M10 x 1,25	C	-
993-03-32CBK	M10 x 1,25	C	Black
993-03-32CH	M10 x 1,25	CH	-
993-03-32D	M10 x 1,25	D	Red
993-03-32DBK	M10 x 1,25	D	Black
993-03-32DBU	M10 x 1,25	D	Blue
993-03-32Z1	M10 x 1,25	Z1	-



Double banjo bolt JIC



Code	Thread	Mat	Note
773-03C	3/8 x 24	C	-
773-03CBK	3/8 x 24	C	Black
773-03CH	3/8 x 24	CH	-
773-03LCH	3/8 x 24	CH	Long (40 mm under hex)
773-03LZ1	3/8 x 24	Z1	Long (40 mm under hex)
773-03Z1	3/8 x 24	Z1	-



Double banjo bolt BSP



Code	Thread	Mat	Note
1013-03P	BSP 1/8"	P	-



Single brakelight banjo bolt UNF



Code	Thread	Mat	Note
BL775-03C	3/8 x 24	C	-
BL775-03SC	3/8 x 24	C	Short



Single brakelight banjo bolt metric

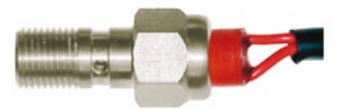

Code	Thread	Mat	Note
BL992-31C	M10 x 1,00	C	-
BL992-31SC	M10 x 1,00	C	Short (18,5 mm under hex)
BL992-32C	M10 x 1,25	C	-



Double brakelight banjo bolt metric



Code	Thread	Mat	Note
BL993-31C	M10 x 1,00	C	-
BL993-31SC	M10 x 1,00	C	Short (28 mm under hex)
BL993-32C	M10 x 1,25	C	-



Single banjo bolt with bleed nipple JIC



Code	Thread	Mat	Note
775-03BNC	3/8 x 24	C	-
775-03BNZ1	3/8 x 24	Z1	-



Single banjo bolt metric



Code	Thread	Mat	Note
992-02-21C	M08 x 1,00	C	-02 hole
992-02-22C	M08 x 1,25	C	-02 hole
992-03-21C	M08 x 1,00	C	-03 hole
992-03-22C	M08 x 1,25	C	-03 hole
992-03-31C	M10 x 1,00	C	-03 hole
992-03-31CH	M10 x 1,00	CH	-03 hole
992-03-31D	M10 x 1,00	D	-03 hole - red
992-03-31DBK	M10 x 1,00	D	-03 hole - black
992-03-31DBU	M10 x 1,00	D	-03 hole - blue
992-03-31LC	M10 x 1,00	C	Long (25 mm under hex)
992-03-31LCH	M10 x 1,00	CH	Long (25 mm under hex)
992-03-31LZ1	M10 x 1,00	Z1	Long (25 mm under hex)
992-03-31SC	M10 x 1,00	C	Short (18 mm under hex)
992-03-31SCBK	M10 x 1,00	C	Short (18 mm under hex) - black
992-03-31SD	M10 x 1,00	D	Short (18 mm under hex) - red
992-03-31SDBK	M10 x 1,00	D	Short (18 mm under hex) - black
992-03-31SDBU	M10 x 1,00	D	Short (18 mm under hex) - blue
992-03-31SZ1	M10 x 1,00	Z1	Short (18 mm under hex)
992-03-31Z1	M10 x 1,00	Z1	-03 hole
992-03-32C	M10 x 1,25	C	-03 hole
992-03-32CBK	M10 x 1,25	C	-03 hole - black
992-03-32CH	M10 x 1,25	CH	-03 hole
992-03-32D	M10 x 1,25	D	-03 hole - red
992-03-32DBK	M10 x 1,25	D	-03 hole - black
992-03-32DBU	M10 x 1,25	D	-03 hole - blue
992-03-32LCH	M10 x 1,25	CH	Long (25 mm under hex)
992-03-32LZ1	M10 x 1,25	Z1	Long (25 mm under hex)
992-03-32Z1	M10 x 1,25	Z1	-03 hole
992-03-35C	M10 x 1,50	C	-03 hole
992-03-35LZ1	M10 x 1,50	Z1	Long (25 mm under hex)
992-03-35Z1	M10 x 1,50	Z1	-03 hole

BANJO BOLTS

B: Brass - C: Stainless steel - CH: Chrome plated - D: Aluminium - P: Zinc plated carbon steel - Z1: Silver plated carbon steel



992BN

Single banjo bolt with bleed nipple metric



Code	Thread	Mat	Note
992-03-21BNC	M08 x 1,00	C	For banjo -03
992-31BNC	M10 x 1,00	C	-
992-31BNCH	M10 x 1,00	CH	-
992-31BNSC	M10 x 1,00	C	Short
992-31BNZ1	M10 x 1,00	Z1	-
992-32BNC	M10 x 1,25	C	-
992-32BNZ1	M10 x 1,25	Z1	-



773BN

Double banjo bolt with bleed nipple UNF



Code	Thread	Mat	Note
773-03BNC	3/8 x 24	C	-



993BN

Bleed nipple double banjo bolt metric



Code	Thread	Mat	Note
993-31BNC	M10 x 1,00	C	-
993-31BNSC	M10 x 1,00	C	Short (28 mm under hex)
993-31BNZ1	M10 x 1,00	Z1	-
993-32BNC	M10 x 1,25	C	-
993-32BNZ1	M10 x 1,25	Z1	-

BLEED NIPPLES



BN506

Bleed nipple UNF



Code	Thread	Mat
BN506C	3/8 x 24	C
BN506P	3/8 x 24	P



BN510

Bleed nipple metric



Code	Thread	Mat
BN510C	M10 x 1,00	C
BN510P	M10 x 1,00	P



BNSB

Speed bleeder

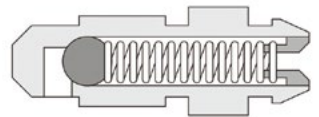

Code	Thread	Mat
BN506PSB	3/8 x 24	P
BN506PSB-HD	3/8 x 24 Harley D	P
BN507PSB	M7 x 1,00	P
BN508PSB	M8 x 1,25	P
BN510PSB	M10 x 1,00	P
BN512PSB	M10 x 1,25	P
BN561PSB	M6 x 1,00	P
BN704PSB	1/4 x 28	P



BN507

Bleed nipple metric



Code	Thread	Mat
BN507C	M7 x 1,00	C
BN507P	M7 x 1,00	P



BN704

Bleed nipple UNF



Code	Thread	Mat
BN704C	1/4 x 28	C
BN704P	1/4 x 28	P



BN508

Bleed nipple metric



Code	Thread	Mat
BN508C	M8 x 1,25	C



BN-CAP

Bleed nipple cap



Code	Thread	Mat
BN-CAP	-	Rubber

SPECIAL APPLICATION BLOCK ADAPTORS

B: Brass - C: Stainless steel - CH: Chrome plated - D: Aluminium - P: Zinc plated carbon steel - Z1: Silver plated carbon steel



Banjo adaptor block 90°

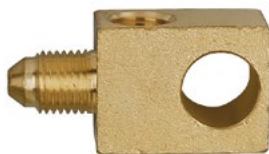

Code	Note	Thread	Hole Size	Mat
G105-31Z1	Mustang/ Cherokee	M10 x 1,00 inv.	-	Z1
G105-31A	Mustang/ Cherokee	M10 x 1,00 inv.	-	B
G105A	Mustang/ Cherokee	3/8 x 24 inv.	-	B



Adaptor block metric 90° Honda



Code	Note	Thread	Hole Size	Mat
G124C	Honda	M10 x 1,00	M8 x 1,25	C



Straight fitting motorcycle convex



Code	Note	Thread	Hole Size	Mat
SP-241T	Motorcycle ABS	M10 x 1,00	M6 x 1,00	C



Angled banjo adaptor block



Code	Note	Thread	Hole Size	Mat
G106A	Ford	-	3/8	B



90° fitting motorcycle convex



Code	Note	Thread	Hole Size	Mat
SP-202	Honda/BMW/ CBS	M10 x 1,00	-	C



Brake hose grommet



Code	Note	Thread	Hole Size	Mat
GR1	To suit 600-03 uncovered hose	-	-	Rubber
GR2	To suit 600-03 covered & uncovered hose	-	-	Rubber
GR3	To suit 600-03 covered	-	-	Rubber



Mazda MX5 rear brake adaptor block



Code	Note	Thread	Hole Size	Mat
G114	Mazda	M10 x 1,00 female -03 tail	-	P



Tee fitting motorcycle convex



Code	Note	Thread	Hole Size	Mat
SP-203	Honda	M10 x 1,00	-	C



Rear tee block GM



Code	Note	Thread	Hole Size	Mat
G115	Chevrolet	M10 x 1,00 femelle - 3/8 x 24 male	-	B



Tee fitting motorcycle concave



Code	Note	Thread	Hole Size	Mat
SP-225	BMW	-03 tail with M10 x 1,00	-	C

The 600 series hose range is a PTFE lined hose, wrapped in a stainless steel braid; designed for brake, clutch, fuel, oil, water, dampers, power steering, gear shift and active differential applications. AN-04, AN-06 & AN-08 bore sizes are available in medium pressure and high pressure variants.

The 700 series hose range is a motorsport use only PTFE lined light weight equivalent to the 600 series, wrapped in an Aramid fibre braid; designed for use with brake, clutch, pressure gauge, fuel injection, fire extinguisher, nitrous & hydraulics.

Used by teams competing in F1, INDYCAR, WEC, NASCAR, WRC, GT, BTCC, WTCR and club level motorsports.



GOODRIDGE
FLUID TRANSFER SYSTEMS
600MP hose series

600 series Medium Pressure AN-04, AN-05, AN-06 & AN-08 bore size hoses are designed for fuel, oil, water and damper reservoir fluid transfer systems. The 600 series hose strongly resists expansion under high pressure and temperature. The Stainless Steel braid offers abrasion, corrosion and fire resistance, which also provides heat protection to 260°C.

Note: Temperature affects maximum working pressure as listed; for temps above 130° C reduce the working pressure by 0.75% for each degree above 130° C. Max 260° C.

Fluid applications:
Fuel, Oil, Water, Dampers

Construction:
Stainless steel braid with PTFE liner
(Optional carbon look or clear covering available)

Compatible fittings:
600MP reusable
600MP crimp

Please note:
Other hose sizes are available with coatings by special request. Anti-static used in sizes dash 4 upwards.

Code	Dash No	Bore size mm (in)	Cover	Nominal hose OD mm (in)	Cover outer Ø mm (in)	PTFE wall mm (in)	Cover wall mm (in)	Working pressure BAR (PSI)	Burst pressure BAR (PSI)	Weight Kg/m (Lb/Ft)	Temperature range °C (°F)	Min. bend radius mm (in)
600-04	-04	5,0 (0,197)	None	7,65 (0,301)	-	0,76 (0,003)	-	290 (4206)	870 (12618)	0,075 (0,05)	-70/+260 (-94/+500)	50 (1,97)
600-04BK	-04	5,0 (0,197)	Black	7,65 (0,301)	8,65 (0,340)	0,76 (0,003)	0,5 (0,019)	290 (4206)	870 (12618)	0,098 (0,066)	-10/+60 (+14/+140)	50 (1,97)
600-04CB	-04	5,0 (0,197)	Carboline	7,65 (0,301)	8,65 (0,340)	0,76 (0,003)	0,5 (0,019)	290 (4206)	870 (12618)	0,098 (0,066)	-10/+60 (+14/+140)	50 (1,97)
600-04CL	-04	5,0 (0,197)	Clear	7,65 (0,301)	8,65 (0,340)	0,76 (0,003)	0,5 (0,019)	290 (4206)	870 (12618)	0,098 (0,066)	-10/+60 (+14/+140)	50 (1,97)
600-05	-05	6,3 (0,248)	None	8,77 (0,345)	-	0,76 (0,003)	-	270 (3916)	810 (11748)	0,105 (0,071)	-70/+260 (-94/+500)	70 (2,756)
600-05CB	-05	6,3 (0,248)	Carboline	8,77 (0,345)	10,16 (0,400)	0,76 (0,003)	0,5 (0,019)	270 (3916)	810 (11748)	0,105 (0,071)	-10/+60 (+14/+140)	70 (2,756)
600-05CL	-05	6,3 (0,248)	Clear	8,77 (0,345)	10,16 (0,400)	0,76 (0,003)	0,5 (0,019)	270 (3916)	810 (11748)	0,105 (0,071)	-10/+60 (+14/+140)	70 (2,756)
600-06	-06	8,2 (0,323)	None	10,86 (0,428)	-	0,76 (0,003)	-	220 (3191)	660 (9572)	0,135 (0,091)	-70/+260 (-94/+500)	100 (3,937)
600-08	-08	10,6 (0,417)	None	13,46 (0,530)	-	0,76 (0,003)	-	190 (2756)	570 (8267)	0,149 (0,100)	-70/+260 (-94/+500)	130 (5,118)



GOODRIDGE
FLUID TRANSFER SYSTEMS
700K hose series (AN-04)

The 700 series hose range is a PTFE lined light weight equivalent to the 600 series, wrapped in an Aramid fibre braid. Motorsport use only. Applications include brake, clutch, fuel injection, fire extinguisher, nitrous, pressure gauge & hydraulics. The PTFE liner is braided in light weight Aramid fibre, providing consistent brake and clutch pedal/lever feel (When used for brake/clutch applications), whilst eliminating any sponginess that may be found with the equivalent rubber hose.

Note: Temperature affects maximum working pressure as listed; for temps above 130° C reduce the working pressure by 0.75% for each degree above 130° C. Max 185° C.

Fluid applications:
Brake, Clutch, Pressure Gauge, Fuel Injection, Fire extinguisher, Nitrous & Hydraulics.

Construction:
Aramid Fibre outer braid with PTFE liner

Compatible fittings:
600MP crimp (special equipment required)

Code	Dash No	Bore size mm (in)	Cover	Nominal hose OD mm (in)	Cover outer Ø mm (in)	PTFE wall mm (in)	Cover wall mm (in)	Working pressure BAR (PSI)	Burst pressure BAR (PSI)	Weight Kg/m (Lb/Ft)	Temperature range °C (°F)	Min. bend radius mm (in)
700K-04BK	-04	5,1 (0,201)	Black PVC	7,65 (0,301)	9,6 (0,378)	0,76 (0,030)	0,9 (0,035)	150 (2175)	450 (6526)	0,074 (0,05)	-20/+85 (-4/+185)	50 (1,968)

RE-USABLE FITTINGS

B: Brass - C: Stainless steel - CH: Chrome plated - D: Aluminium - P: Zinc plated carbon steel - Z1: Silver plated carbon steel

600 MP JIC/UNF Reusable fittings for 600MP series hose (AN-04, AN-06 & AN-08)



6001MP

Straight female.



Code	To suit hose	Thread	Mat	Note
6001-04C	-04	7/16 x 20	C	-
6001-04D	-04	7/16 x 20	D	red/blue
6001-04P	-04	7/16 x 20	P	-
6001-06D	-06	9/16 x 18	D	red/blue
6001-06P	-06	9/16 x 18	P	-
6001-08D	-08	3/4 x 16	D	red/blue



6091MP

90° swept tube female.



Code	To suit hose	Thread	Mat	Note
6091-04C	-04	7/16 x 20	C	-
6091-04D	-04	7/16 x 20	D	red/blue
6091-04P	-04	7/16 x 20	P	-
6091-06D	-06	9/16 x 18	D	red/blue
6091-06P	-06	9/16 x 18	P	-
6091-08D	-08	3/4 x 16	D	red/blue



6180MP

180° swept tube female.



Code	To suit hose	Thread	Mat	Note
6180-06D	-06	9/16 x 18	D	red/blue



6045MP

45° forged female.



Code	To suit hose	Thread	Mat	Note
6045-04D	-04	7/16 x 20	D	red/blue
6045-06D	-06	9/16 x 18	D	red/blue
6045-08D	-08	3/4 x 16	D	red/blue



6090MP

90° forged female.



Code	To suit hose	Thread	Mat	Note
6090-04D	-04	7/16 x 20	D	red/blue
6090-06D	-06	9/16 x 18	D	red/blue
6090-08D	-08	3/4 x 16	D	red/blue



441MP

Straight male convex



Code	To suit hose	Thread	Mat	Note
441-04C	-04	7/16 x 20	C	-



6046MP

45° swept tube female.



Code	To suit hose	Thread	Mat	Note
6046-04C	-04	7/16 x 20	C	-
6046-04D	-04	7/16 x 20	D	red/blue
6046-04P	-04	7/16 x 20	P	-
6046-06D	-06	9/16 x 18	D	red/blue
6046-08D	-08	3/4 x 16	D	red/blue



6690MP

90° forged female double swivel.



Code	To suit hose	Thread	Mat	Note
6690-04C	-04	7/16 x 20	C	-
6690-04D	-04	7/16 x 20	D	red/blue
6690-06D	-06	9/16 x 18	D	red/blue



443MP

Straight male bulkhead



Code	To suit hose	Thread	Mat	Note
443-04P	-04	7/16 x 20	P	-



704MP

Female bulkhead convexe



Code	To suit hose	Thread	Mat	Note
704-04P	-04	7/16 x 20	P	Use locknut part no 2k8686



6645MP

45° forged female double swivel.



Code	To suit hose	Thread	Mat	Note
6645-04C	-04	7/16 x 20	C	-
6645-04D	-04	7/16 x 20	D	red/blue
6645-06D	-06	9/16 x 18	D	red/blue



6120MP

120° swept tube female.



Code	To suit hose	Thread	Mat	Note
6120-06D	-06	9/16 x 18	D	red/blue
6120-08D	-08	3/4 x 16	D	red/blue

RE-USABLE FITTINGS

B: Brass - C: Stainless steel - CH: Chrome plated - D: Aluminium - P: Zinc plated carbon steel - Z1: Silver plated carbon steel

600 MP BSP Reusable fittings for 600MP series hose (AN-04)



Straight female



Code	To suit hose	Thread	Mat	Note
321-04P	-04	BSP 1/4"	P	-



90° swept tube female



Code	To suit hose	Thread	Mat	Note
332-04P	-04	BSP 1/4"	P	-

600 SERIES BANJO REUSABLE FITTINGS (AN -04, AN-06 & AN-08)



Re-usable - Straight banjo.



Code	To suit hose	Hole size	Mat	Note
5091-04-03P	-04	3/8" (10 mm)	P	-
5091-04D	-04	7/16" (11,2 mm)	D	-
5091-04-M12P	-04	M12	P	-
5091-04P	-04	7/16" (11,2 mm)	P	-
5091-06D	-06	-06 (14 mm)	D	red/blue
5091-08D	-08	-08 (19 mm)	D	red/blue



Re-usable - straight banjo extended neck



Code	To suit hose	Hole size	Mat	Note
5092-04-03P	-04	3/8" (10 mm)	P	-



Re-usable - 20° banjo extended neck



Code	To suit hose	Hole size	Mat	Note
5093-04-03P	-04	3/8" (10 mm)	P	-

OLIVES AND SOCKETS



Replacement olive for 600MP hose



Code	Mat	To suit
1205-04B	B	-04
1205-04D	D	-04
1205-06B	B	-06
1205-06D	D	-06
1205-08D	D	-08



Replacement sockets for 600MP hose



Code	Mat	To suit
1206-04P	P	-04
1206-06D	D	-06
1206-08D	D	-08

CRIMP FITTINGS

B: Brass - C: Stainless steel - CH: Chrome plated - D: Aluminium - P: Zinc plated carbon steel - Z1: Silver plated carbon steel

600 MP JIC/UNF Crimp fittings (AN-04, AN-06 & AN-08)



Straight female



Code	To suit hose	Thread	Mat	Note
S6001-04CMP	-04	7/16 x 20	C	-
S6001-04DMP	-04	7/16 x 20	D	-
S6001-04Z1MP	-04	7/16 x 20	Z1	-
S6001-05-04CMP	-05	7/16x20	C	-
S6001-06CMP	-06	9/16 x 18	C	-
S6001-06DMP	-06	9/16 x 18	D	-
S6001-08DMP	-08	3/4 x 16	D	-



Straight Swage female



Code	To suit hose	Thread	Mat	Note
S747-44Z1	-04	7/16 x 24	Z1	-



45° swept tube female



Code	To suit hose	Thread	Mat	Note
S6046-04CMP	-04	7/16 x 20	C	-
S6046-04DMP	-04	7/16 x 20	D	-
S6046-04Z1MP	-04	7/16 x 20	Z1	-
S6046-06DMP	-06	9/16 x 18	D	-



45° forged female



Code	To suit hose	Thread	Mat	Note
S6045-04CMP	-04	7/16 x 20	C	-
S6045-04DMP	-04	7/16 x 20	D	-
S6045-06DMP	-06	9/16 x 18	D	-



90° swept tube female concave seat



Code	To suit hose	Thread	Mat	Note
S6091-04CMP	-04	7/16 x 20	C	-
S6091-04DMP	-04	7/16 x 20	D	-
S6091-04Z1MP	-04	7/16 x 20	Z1	-
S6091-06DMP	-06	9/16 x 18	D	-



90° forged female



Code	To suit hose	Thread	Mat	Note
S6090-04CMP	-04	7/16 x 20	C	-
S6090-04DMP	-04	7/16 x 20	D	-
S6090-06DMP	-06	9/16 x 18	D	-
S6090-08DMP	-08	3/4 x 16	D	-

600 MP NPT crimp fittings (AN-04)



Crimp fitting - Straight male NPT



Code	To suit hose	Thread	Mat	Note
S816-04-03P2MP	-04	NPT 1/8"	B	-

i Crimp service and customized assembly

Gieffe Racing offers an assembly service for all types of crimp fittings. When ordering, it is sufficient to provide a technical drawing or the dimensional specifications for the assembly required. Before delivery each assembly is individually tested at the working pressure. Racing gieffe not recommend the use of not proven reliability equipment, which do not guarantee the standards specified by the manufacturer. Contact us for more information.



600 MEDIUM PRESSURE SWAGE/CRIMP BANJOS (AN-04 & AN-05)

B: Brass - C: Stainless steel - CH: Chrome plated - D: Aluminium - P: Zinc plated carbon steel - Z1: Silver plated carbon steel



Banjo



Code	To suit hose	Hole size	Note	Mat
S5091-04-03C	-04	3/8" (10 mm)	-	C
S5091-04-03Z1	-04	3/8" (10 mm)	-	Z1
S5091-04-M12CMP	-04	12 mm	-	C
S5091-04-M12Z1	-04	12 mm	-	Z1
S5091-04Z1MP	-04	7/16" (11,2 mm)	-	Z1
S5091-05-M10CMP	-05	10 mm	-	C
S5091-05-M12Z1	-05	12 mm	-	Z1
S5091-06-M12DMP	-06	12 mm	-	D
S5091-06-M14DMP	-06	14 mm	-	D



Straight banjo extended neck



Code	To suit hose	Hole size	Note	Mat
S5092-04-03C	-04	3/8" (10 mm)	-	C



Straight banjo with integral swivel



Code	To suit hose	Hole size	Note	Mat
S5092-05-M10CSW	-05	-	M10 x 1,0	C
S5092-05-M12CSW	-05	-	M12 x 1,5	C

BANJO BOLTS



Single banjo bolt



Code	Thread	Mat	Note
1012-04P	BSP 1/4"	P	-



Double banjo bolt



Code	Thread	Mat	Note
773-44CH	7/16 x 24	CH	-



Single brakelight banjo bolt UNF



Code	Thread	Mat	Note
BL775-44C	7/16 x 24	C	Short

MEDIUM PRESSURE CRIMP COLLARS



Crimp collar



Code	To suit	Mat
RC600-04CMP	-04 MP	C
RC600-05CMP	-05 MP	C
RC600-06CMP	-06 MP	C
RC600-08CMP	-08 MP	C



600 HP Hose

The 600HP (High Pressure) series features a smooth bore PTFE liner, wrapped in tightly woven aramid fibre and outer 304 grade Stainless Steel braid. The Stainless-Steel braid offers abrasion, corrosion and fire resistance, which also provides heat protection to 260°C. Compatible with HP crimp fittings only. (Specialist equipment required).

Fluid applications:

Power steering, Gear shift, Active aero & High pressure hydraulics.

Construction:

Corrosion and fire resistant Stainless-steel braid with aramid fibre under braid and PTFE liner

Compatible fittings:

600HP Crimp = AN-04HP, AN-06HP & AN-08HP

Please note:

Anti-static.

Code	Dash No	Bore size mm (in)	Nominal hose OD mm (in)	PTFE wall mm (in)	Working pressure BAR (PSI)	Burst pressure BAR (PSI)	Weight Kg/m (Lb/Ft)	Temperature range °C (°F)	Min. bend radius mm (in)
600-04HP	-04	5,1 (0,201)	8,9 (0,350)	0,76 (0,003)	375 (6889)	1500 (21755)	0,119 (0,080)	-70/+260 (-94/+500)	45 (1,772)
600-06HP	-06	8,2 (0,323)	12,3 (0,484)	0,76 (0,003)	325 (4713)	1300 (18854)	0,164 (0,110)	-70/+260 (-94/+500)	70 (0,276)
600-08HP	-08	10,6 (0,417)	14,8 (0,583)	0,76 (0,003)	250 (3625)	1000 (14503)	0,193 (0,130)	-70/+260 (-94/+500)	90 (3,543)

HP CRIMP FITTINGS

B: Brass - C: Stainless steel - CH: Chrome plated - D: Aluminium - P: Zinc plated carbon steel - Z1: Silver plated carbon steel



S6001

Straight female concave



Code	To suit hose	Thread	Mat
S6001-04CHP	-04 high pressure	JIC 7/16" x 20	C
S6001-06CHP	-06 high pressure	JIC 9/16" x 18	C
S6001-08CHP	-08 high pressure	JIC 3/4" x 16	C



S6120

120° swept tube female medium/high pressure



Code	To suit hose	Thread	Mat
S6120-04CHP	-04 high pressure	JIC 7/16" x 20	C
S6120-06CHP	-06 high pressure	JIC 9/16" x 18	C



S6180

180° swept tube female medium/high pressure



Code	To suit hose	Thread	Mat
S6180-04CHP	-04 high pressure	JIC 7/16" x 20	C



S6046

45° swept tube female medium/high pressure concave



Code	To suit hose	Thread	Mat
S6046-04CHP	-04 high pressure	JIC 7/16" x 20	C
S6046-06CHP	-06 high pressure	JIC 9/16" x 18	C
S6046-08CHP	-08 high pressure	JIC 3/4" x 16	C



S6150

150° swept tube female medium/high pressure



Code	To suit hose	Thread	Mat
S6150-04CHP	-04 high pressure	JIC 7/16" x 20	C



S6091

90° swept tube female medium/high pressure



Code	To suit hose	Thread	Mat
S6091-04CHP	-04 high pressure	JIC 7/16" x 20	C
S6091-06CHP	-06 high pressure	JIC 9/16" x 18	C
S6091-08CHP	-08 high pressure	JIC 3/4" x 16	C

HP CRIMP COLLARS



RC600HP

Collars to suit 600 series hose high pressure



Code	To suit hose:	Mat
RC600-04CHP	-04 high pressure	C
RC600-06CHP	-06 high pressure	C
RC600-08CHP	-08 high pressure	C

Goodridge 200 series rubber lined hoses are compatible with Goodridge 236 cutter style fittings, ideal for use with 'push fit' applications. Available in bore sizes AN-04 to AN-16.
 The 200 series hose features a reinforced chlorinated Polyethylene (CPE) synthetic rubber liner, wrapped in a double stainless steel external braid for additional resistance to abrasion.
 The 210 series hose features a reinforced chlorinated Polyethylene (CPE) synthetic rubber liner, wrapped in a stainless steel internal braid and light weight nylon external braid; for use where the additional abrasive resistant stainless steel braided 200 series hose is not required.
 The 202 series hose is a single braided hose, for use with 936 hose finishers.

Benefits:

- Uninterrupted flow
- Burst pressure up to 1000 PSI / 69 BAR (200-04)
- Temperature resistance from (-49°C to +150°C).
- Bend radius to 50mm (AN-04)

Features:

- Smooth bore
- Integral stainless steel braid
- Rubber lined
- Fibre / Stainless steel braided options

Tipo di raccordo:

- Reusable - cutter style
- Push fit

Fluid applications:
 Fuel, Oil, Coolant, Water and Methanol

Compatible fittings:
 236, 336, 2776 & 936 hose finishers.
 (202 series compatible with 936 only)



The 200 series hose features a stainless-steel reinforced elastomer core, wrapped in a stainless-steel external braid for additional abrasive resistance. Ideal for use outside the cockpit, engine bay and underneath vehicles where abrasive protection is required.

Fluid applications:
 Fuel, Oil, Coolant, Water and Methanol.

Compatible fittings:
 236, 336, 2776 & 936 hose finishers.

Please Note: Not to be used for fuel inside cockpit.

Code	Dash No	Bore size mm (in)	Nominal hose OD mm (in)	Working pressure BAR (PSI)	Burst pressure BAR (PSI)	Weight Kg/m (Lb/Ft)	Temperature range °C (°F)	Min. bend radius mm (in)
200-04	-04	5,4 (0,212)	11,2 (0,440)	69 (1000)	414 (6000)	0,179 (0,12)	-40/+150 (-65/+302)	50,80 (2,00)
200-06	-06	8,70 (0,329)	14,20 (0,558)	69 (1000)	414 (6000)	0,208 (0,14)	-40/+150 (-65/+302)	63,50 (2,50)
200-08	-08	11,1 (0,463)	17,1 (0,762)	69 (1000)	345 (5000)	0,25 (0,17)	-40/+150 (-65/+302)	88,90 (3,50)
200-10	-10	14,2 (0,558)	20,8 (0,817)	69 (1000)	345 (5000)	0,327 (0,22)	-40/+150 (-65/+302)	101,6 (4,00)
200-12	-12	17,4 (0,684)	24,4 (0,959)	69 (1000)	259 (3750)	0,402 (0,27)	-40/+150 (-65/+302)	114,3 (4,50)
200-16	-16	22,2 (0,872)	30,5 (1,199)	52 (750)	172 (2500)	0,610 (0,41)	-40/+150 (-65/+302)	139,70 (5,50)



The 210 series hose features a stainless steel reinforced chlorinated Polyethylene (CPE) synthetic rubber liner, wrapped in a black light-weight fibre braid. Ideal for use in protected areas outside the cockpit - engine bay fuel, coolant and oil plumbing.

Fluid applications:
 Fuel, Oil, Coolant, Water and Methanol.

Compatible fittings:
 236, 336, 2776 & 936 hose finishers.

Please Note: Not to be used for fuel inside cockpit.

Code	Dash No	Bore size mm (in)	Nominal hose OD mm (in)	Working pressure BAR (PSI)	Burst pressure BAR (PSI)	Weight Kg/m (Lb/Ft)	Temperature range °C (°F)	Min. bend radius mm (in)
210-04	-04	5,4 (0,212)	11,2 (0,440)	34 (500)	138 (2000)	0,112 (0,075)	-40/+150 (-40/+302)	50,80 (2,00)
210-06	-06	8,7 (0,342)	14,2 (0,558)	34 (500)	138 (2000)	0,141 (0,095)	-40/+150 (-40/+302)	63,50 (2,50)
210-08	-08	11,1 (0,436)	17,1 (0,672)	34 (500)	138 (2000)	0,179 (0,120)	-40/+150 (-40/+302)	88,90 (3,50)
210-10	-10	14,2 (0,558)	20,8 (0,817)	34 (500)	138 (2000)	0,231 (0,115)	-40/+150 (-40/+302)	101,60 (4,00)
210-12	-12	17,4 (0,684)	24,4 (0,959)	24 (350)	97 (1400)	0,372 (0,250)	-40/+150 (-40/+302)	114,30 (4,50)
210-16	-16	22,2 (0,872)	30,5 (1,199)	24 (350)	97 (1400)	0,476 (0,320)	-40/+150 (-40/+302)	139,70 (5,50)



The 202 hose is a rubber lined, single braid hose for use with low pressure applications. Compatible with 936 hose finishers.

Fluid applications:
 Fuel, Oil, Coolant, Water and Methanol.

Compatible fittings:
 936 hose finishers.

Notes: Not to be used with 1136, 236, 2776 or 536 fittings.

Code	Dash No	Bore size mm (in)	Nominal hose OD mm (in)	Working pressure BAR (PSI)	Burst pressure BAR (PSI)	Weight Kg/m (Lb/Ft)	Temperature range °C (°F)	Min. bend radius mm (in)
202-04	-04	6,35 (0,250)	11,70 (0,461)	63 (916)	350 (5076)	-	-20/+150 (+4/+302)	38 (1,50)
202-05	-05	7,95 (0,313)	13,25 (0,522)	63 (916)	350 (5076)	-	-20/+150 (+4/+302)	45 (1,77)
202-06	-06	9,53 (0,375)	15,50 (0,610)	63 (916)	350 (5076)	-	-20/+150 (+4/+302)	53 (2,09)

RE-USABLE FITTINGS

B: Brass - C: Stainless steel - CH: Chrome plated - D: Aluminium - P: Zinc plated carbon steel - Z1: Silver plated carbon steel

236/1136 SERIES
JIC Fittings



Straight female



Code	To suit hose	Thread	Mat	Colour
1136-0104	200-04	7/16 x 20	D	red/blue
236-0106	200-06	9/16 x 18	D	red/blue
236-0108	200-08	3/4 x 16	D	red/blue
236-0110	200-10	7/8 x 14	D	red/blue
236-0112	200-12	1 1/16 x 12	D	red/blue
236-0116	200-16	1 5/16 x 12	D	red/blue



60° female swept tube

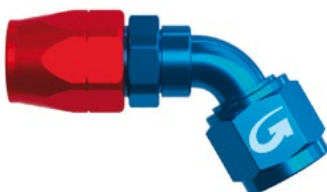

Code	To suit hose	Thread	Mat	Colour
236-6106	200-06	9/16 x 18	D	red/blue
236-6108	200-08	3/4 x 16	D	red/blue
236-6110	200-10	7/8 x 14	D	red/blue
236-6112	200-12	1 1/16 x 12	D	red/blue
236-6116	200-16	1 5/16 x 12	D	red/blue



150° female swept tube



Code	To suit hose	Thread	Mat	Colour
236-15006	200-06	9/16 x 18	D	red/blue
236-15008	200-08	3/4 x 16	D	red/blue
236-15010	200-10	7/8 x 14	D	red/blue
236-15012	200-12	1 1/16 x 12	D	red/blue
236-15016	200-16	1 5/16 x 12	D	red/blue



30° female swept tube

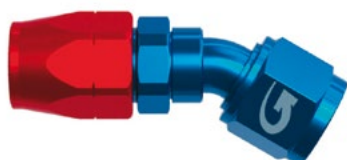

Code	To suit hose	Thread	Mat	Colour
236-3106	200-06	9/16 x 18	D	red/blue
236-3108	200-08	3/4 x 16	D	red/blue
236-3110	200-10	7/8 x 14	D	red/blue
236-3112	200-12	1 1/16 x 12	D	red/blue
236-3116	200-16	1 5/16 x 12	D	red/blue



90° female swept tube



Code	To suit hose	Thread	Mat	Colour
1136-9004	200-04	7/16 x 20	D	red/blue
236-9006	200-06	9/16 x 18	D	red/blue
236-9008	200-08	3/4 x 16	D	red/blue
236-9010	200-10	7/8 x 14	D	red/blue
236-9012	200-12	1 1/16 x 12	D	red/blue
236-9016	200-16	1 5/16 x 12	D	red/blue



180° female swept tube



Code	To suit hose	Thread	Mat	Colour
236-18006	200-06	9/16 x 18	D	red/blue
236-18008	200-08	3/4 x 16	D	red/blue
236-18010	200-10	7/8 x 14	D	red/blue
236-18012	200-12	1 1/16 x 12	D	red/blue
236-18016	200-16	1 5/16 x 12	D	red/blue



45° female swept tube

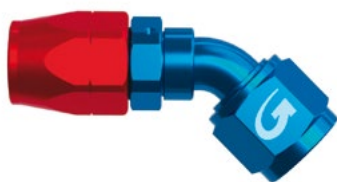

Code	To suit hose	Thread	Mat	Colour
1136-4504	200-04	7/16 x 20	D	red/blue
236-4506	200-06	9/16 x 18	D	red/blue
236-4508	200-08	3/4 x 16	D	red/blue
236-4510	200-10	7/8 x 14	D	red/blue
236-4512	200-12	1 1/16 x 12	D	red/blue
236-4516	200-16	1 5/16 x 12	D	red/blue



120° female swept tube



Code	To suit hose	Thread	Mat	Colour
236-12006	200-06	9/16 x 18	D	red/blue
236-12008	200-08	3/4 x 16	D	red/blue
236-12010	200-10	7/8 x 14	D	red/blue
236-12012	200-12	1 1/16 x 12	D	red/blue
236-12016	200-16	1 5/16 x 12	D	red/blue



Socket



Code	To suit hose	Thread	Mat	Colour
1207-06D	200-06	9/16 x 18	D	red
1207-08D	200-08	3/4 x 16	D	red
1207-10D	200-10	7/8 x 14	D	red
1207-12D	200-12	1 1/16 x 12	D	red

RE-USABLE FITTINGS

B: Brass - C: Stainless steel - CH: Chrome plated - D: Aluminium - P: Zinc plated carbon steel - Z1: Silver plated carbon steel



Straight female



Code	To suit hose	Thread	Mat	Colour
1136-0104BK	200-04	7/16 x 20	D	black
236-0106BK	200-06	9/16 x 18	D	black
236-0108BK	200-08	3/4 x 16	D	black
236-0110BK	200-10	7/8 x 14	D	black
236-0112BK	200-12	1 1/16 x 12	D	black
236-0116BK	200-16	1 5/16 x 12	D	black



60° female swept tube



Code	To suit hose	Thread	Mat	Colour
236-6106BK	200-06	9/16 x 18	D	black
236-6108BK	200-08	3/4 x 16	D	black
236-6110BK	200-10	7/8 x 14	D	black
236-6112BK	200-12	1 1/16 x 12	D	black
236-6116BK	200-16	1 5/16 x 12	D	black



150° female swept tube



Code	To suit hose	Thread	Mat	Colour
236-15006BK	200-06	9/16 x 18	D	black
236-15008BK	200-08	3/4 x 16	D	black
236-15010BK	200-10	7/8 x 14	D	black
236-15012BK	200-12	1 1/16 x 12	D	black
236-15016BK	200-16	1 5/16 x 12	D	black



30° female swept tube



Code	To suit hose	Thread	Mat	Colour
236-3106BK	200-06	9/16 x 18	D	black
236-3108BK	200-08	3/4 x 16	D	black
236-3110BK	200-10	7/8 x 14	D	black
236-3112BK	200-12	1 1/16 x 12	D	black
236-3116BK	200-16	1 5/16 x 12	D	black



90° female swept tube



Code	To suit hose	Thread	Mat	Colour
1136-9004BK	200-04	7/16 x 20	D	black
236-9006BK	200-06	9/16 x 18	D	black
236-9008BK	200-08	3/4 x 16	D	black
236-9010BK	200-10	7/8 x 14	D	black
236-9012BK	200-12	1 1/16 x 12	D	black
236-9016BK	200-16	1 5/16 x 12	D	black



180° female swept tube



Code	To suit hose	Thread	Mat	Colour
236-18006BK	200-06	9/16 x 18	D	black
236-18008BK	200-08	3/4 x 16	D	black
236-18010BK	200-10	7/8 x 14	D	black
236-18012BK	200-12	1 1/16 x 12	D	black
236-18016BK	200-16	1 5/16 x 12	D	black



45° female swept tube



Code	To suit hose	Thread	Mat	Colour
1136-4504BK	200-04	7/16 x 20	D	black
236-4506BK	200-06	9/16 x 18	D	black
236-4508BK	200-08	3/4 x 16	D	black
236-4510BK	200-10	7/8 x 14	D	black
236-4512BK	200-12	1 1/16 x 12	D	black
236-4516BK	200-16	1 5/16 x 12	D	black



120° female swept tube



Code	To suit hose	Thread	Mat	Colour
236-12006BK	200-06	9/16 x 18	D	black
236-12008BK	200-08	3/4 x 16	D	black
236-12010BK	200-10	7/8 x 14	D	black
236-12012BK	200-12	1 1/16 x 12	D	black
236-12016BK	200-16	1 5/16 x 12	D	black



Socket



Code	To suit hose	Thread	Mat	Colour
1207-06DBK	200-06	9/16 x 18	D	black
1207-08DBK	200-08	3/4 x 16	D	black
1207-10DBK	200-10	7/8 x 14	D	black
1207-12DBK	200-12	1 1/16 x 12	D	black

RE-USABLE FITTINGS

B: Brass - C: Stainless steel - CH: Chrome plated - D: Aluminium - P: Zinc plated carbon steel - Z1: Silver plated carbon steel

336 SERIES
JIC ReusableFittings



45° female forged elbow

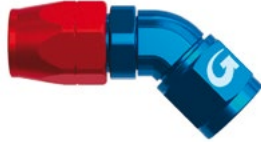

Code	To suit hose	Thread	Mat	Colour
336-4506	200-06	9/16 x 18	D	red/blue
336-4508	200-08	3/4 x 16	D	red/blue
336-4510	200-10	7/8 x 14	D	red/blue
336-4512	200-12	1 1/16 x 12	D	red/blue



90° female forged elbow



Code	To suit hose	Thread	Mat	Colour
336-9006	200-06	9/16 x 18	D	red/blue
336-9008	200-08	3/4 x 16	D	red/blue
336-9010	200-10	7/8 x 14	D	red/blue
336-9012	200-12	1 1/16 x 12	D	red/blue



45° female forged elbow



Code	To suit hose	Thread	Mat	Colour
336-4506BK	200-06	9/16 x 18	D	black
336-4508BK	200-08	3/4 x 16	D	black
336-4510BK	200-10	7/8 x 14	D	black
336-4512BK	200-12	1 1/16 x 12	D	black



90° female forged elbow



Code	To suit hose	Thread	Mat	Colour
336-9006BK	200-06	9/16 x 18	D	black
336-9008BK	200-08	3/4 x 16	D	black
336-9010BK	200-10	7/8 x 14	D	black
336-9012BK	200-12	1 1/16 x 12	D	black

2776 SERIES
JIC Reusable Fittings (designed for Carburettor applications)



Banjo to Hose End

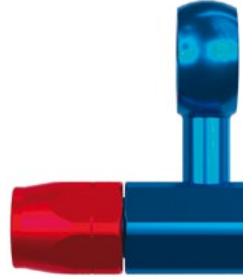

Code	Note	Colour	Thread	Mat
2776-1106	-	red-blue	-	D



Banjo to Hose Connection

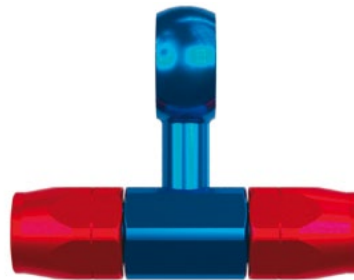

Code	Note	Colour	Thread	Mat
2776-2106	-	red-blue	-	D



Banjo to Hose End to Male On Run

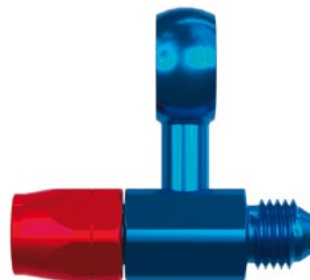

Code	Note	Colour	Thread	Mat
2776-3106	-	red-blue	9/16 x 18	D



Banjo Bolt for Carburetor



Code	Note	Colour	Thread	Mat
2776-06-M122D	requires CW901-M16 washer	red	M12 x 1,25 (Dellorto)	D
2776-06-M12D	requires CW901-M16 washer	red	M12 x 1,5 (Weber)	D



Banjo to Hose End



Code	Note	Colour	Thread	Mat
2776-1106BK	-	black	-	D



Banjo to Hose Connection



Code	Note	Colour	Thread	Mat
2776-2106BK	-	black	-	D



Banjo to Hose End to Male On Run



Code	Note	Colour	Thread	Mat
2776-3106BK	-	black	9/16 x 18	D



Banjo Bolt for Carburetor



Code	Note	Colour	Thread	Mat
2776-06-M122DBK	requires CW901-M16 washer	black	M12 x 1,25 (Dellorto)	D
2776-06-M12DBK	requires CW901-M16 washer	black	M12 x 1,5 (Weber)	D



Hose finisher



Code	Color	Suit 200/210 hose	Suit 202 hose	SuitTF-TU25 hose
936-04DB	Blue	-04 & -05	-04	-
936-04DBK	black	-04 & -05	-04	-
936-04DCH	Chrome plated	-04 & -05	-04	-
936-04DR	Red	-04 & -05	-04	-
936-06DB	Blue	-06 & -07	-05 & -06	-04
936-06DBK	Black	-06 & -07	-05 & -06	-04
936-06DR	Red	-06 & -07	-05 & -06	-04
936-08DB	Blue	-08	-	-06
936-08DBK	black	-08	-	-06
936-08DCH	Chrome plated	-08	-	-06
936-08DR	Red	-08	-	-06
936-10DB	Blue	-10	-	-08

Code	Color	Suit 200/210 hose	Suit 202 hose	SuitTF-TU25 hose
936-10DBK	black	-10	-	-08
936-10DCH	Chrome plated	-10	-	-08
936-10DR	Red	-10	-	-08
936-12DB	Blue	-12	-	-10
936-12DBK	black	-12	-	-10
936-12DCH	Chrome plated	-12	-	-10
936-12DR	Red	-12	-	-10
936-16DB	Blue	-16	-	-
936-16DBK	black	-16	-	-
936-16DCH	Chrome plated	-16	-	-
936-16DR	Red	-16	-	-

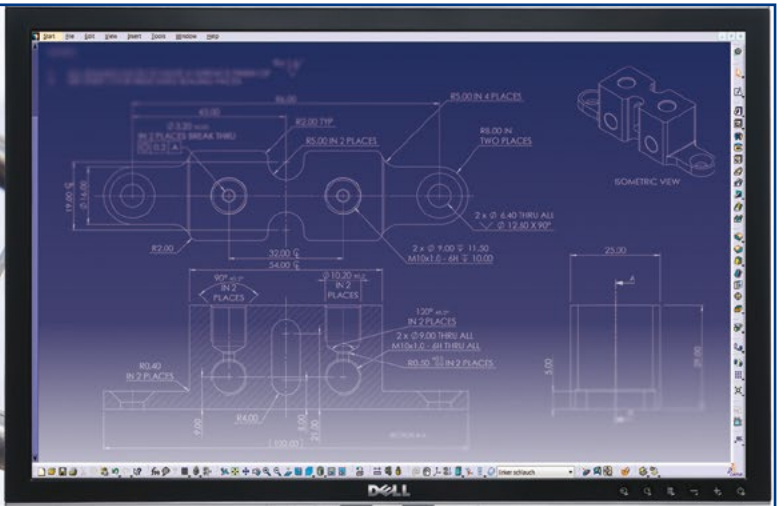

For complex projects, Goodridge has a team of in-house design engineers to offer support and consulting services

Customers are assigned a design engineer and a project manager to follow the processing until the end of the project.



Goodridge 536 series hose and TF-TU25 series hoses are designed for 'push fit' applications. The 536 series is a textile reinforced rubber hose with an abrasive resistant synthetic rubber (Nitrile & PVC) cover. Ideal for low pressure oil breather applications where the external stainless steel abrasive protection of the 200 series hose is not required. The 536 hose is not for 'in cockpit' use and not recommended for vacuum systems. Compatible with 536 'sure lock' fittings. The TF-TU25 is a cotton reinforced rubber hose with a synthetic rubber outer and oil resisting compound inner. Ideal for use with low pressure push fit applications and safe to be used with fuel. Not for use 'in cockpit' and not recommended for vacuum systems. Compatible with push fit hose tails.

Benefits:

- Uninterrupted flow
- Burst pressure up to 1146 PSI / 79 BAR (TF-TU25)
- Temperature resistance from -40°C to 100°C (536)
- Bend radius to 40mm (TF-TU25-04)

Features:

- Smooth bore
- Textile reinforced
- Rubber lined
- Synthetic rubber covering

Fitting Type:
Push fit

Fluid applications:
*Fuel, Oil, Coolant, Air & Water.

Compatible fittings:
536 fittings & 936 hose finishers

Notes: *536 not compatible with all fuel types. Please contact Gieffe Racing.



536

The 536 series is a textile reinforced rubber hose with an elastomer cover. Ideal for low pressure applications where the external abrasive protection of the 200 series hose is not required.

Fluid applications:

Fuel, Oil, Coolant, Air & Water.

Compatible fittings:

536 fittings & 936 hose finishers

Notes:

Not compatible with some fuel types. Please contact Goodridge.

Code	Dash No	Bore size mm (in)	Nominal hose OD mm (in)	Working pressure BAR (PSI)	Burst pressure BAR (PSI)	Weight Kg/m (Lb/Ft)	Temperature range °C (°F)	Min. bend radius mm (in)
536-04	-04	6,35 (0,250)	12,70 (0,499)	17 (247)	69 (1001)	0,10 (0,067)	-40/+100 (-40/+212)	76,20 (3,00)
536-06	-06	9,52 (0,374)	15,87 (0,624)	17 (247)	69 (1001)	0,16 (0,108)	-40/+100 (-40/+212)	76,20 (3,00)
536-08	-08	12,70 (0,499)	19,05 (0,749)	17 (247)	69 (1001)	0,22 (0,148)	-40/+100 (-40/+212)	127,00 (5,00)
536-10	-10	15,87 (0,624)	23,00 (0,904)	17 (247)	69 (1001)	0,30 (0,202)	-40/+100 (-40/+212)	152,40 (6,00)
536-12	-12	19,05 (0,749)	26,19 (1,029)	17 (247)	69 (1001)	0,36 (0,242)	-40/+100 (-40/+212)	177,80 (7,00)



536B

The 536 series is a textile reinforced rubber hose with a black elastomer cover. Ideal for low pressure applications where the external abrasive protection of the 200 series hose is not required.

Fluid applications:

Fuel, Oil, Coolant, Air & Water.

Compatible fittings:

536 fittings & 936 hose finishers

Notes:

Not compatible with some fuel types. Please contact Goodridge.

Code	Dash No	Bore size mm (in)	Nominal hose OD mm (in)	Working pressure BAR (PSI)	Burst pressure BAR (PSI)	Weight Kg/m (Lb/Ft)	Temperature range °C (°F)	Min. bend radius mm (in)
536-04B	-04	6,35 (0,250)	12,70 (0,499)	17 (247)	69 (1001)	0,10 (0,067)	-40/+100 (-40/+212)	76,20 (3,00)
536-06B	-06	9,52 (0,374)	15,87 (0,624)	17 (247)	69 (1001)	0,16 (0,108)	-40/+100 (-40/+212)	76,20 (3,00)
536-08B	-08	12,70 (0,499)	19,05 (0,749)	17 (247)	69 (1001)	0,22 (0,148)	-40/+100 (-40/+212)	127,00 (5,00)
536-10B	-10	15,87 (0,624)	23,00 (0,904)	17 (247)	69 (1001)	0,30 (0,202)	-40/+100 (-40/+212)	152,40 (6,00)
536-12B	-12	19,05 (0,749)	26,19 (1,029)	17 (247)	69 (1001)	0,36 (0,242)	-40/+100 (-40/+212)	177,80 (7,00)



TF-TU25

The TF-TU25 series is a cotton reinforced rubber hose with a black synthetic rubber outer and oil resisting seamless rubber compound inner. Ideal for low pressure applications where the external abrasive protection of the 200 series hose is not required.

Fluid applications:

Fuel, Oil, Coolant and Hydraulic fluids.

Compatible fittings:

536 fittings & 936 hose finishers

Notes:

SAE 100 R6 compliant.

Code	Dash No	Bore size mm (in)	Nominal hose OD mm (in)	Working pressure BAR (PSI)	Burst pressure BAR (PSI)	Weight Kg/m (Lb/Ft)	Temperature range °C (°F)	Min. bend radius mm (in)
TF-TU25-04	-04	6,0 (0,236)	14,0 (0,551)	25 (362,5)	78 (1131)	0,15 (0,101)	-40/+80 (-40/+176)	40 (1,575)
TF-TU25-06	-06	10,0 (0,393)	18,0 (0,709)	25 (363)	78 (1131)	0,25 (0,170)	-40/+80 (-40/+176)	60 (2,36)
TF-TU25-08	-08	13,0 (0,512)	21,0 (0,827)	25 (363)	78 (1131)	0,30 (0,202)	-40/+80 (-40/+176)	80 (3,15)
TF-TU25-10	-10	16,0 (0,630)	25,0 (0,984)	25 (363)	78 (1131)	0,40 (0,269)	-40/+80 (-40/+176)	100 (3,94)



Straight Female Concave Seat



Code	To suit hose	Thread
536-0104	536-04	JIC 7/16" x 20
536-0106	536-06	JIC 9/16" x 18
536-0108	536-08	JIC 3/4" x 16
536-0110	536-10	JIC 7/8" x 14
536-0112	536-12	JIC 1 1/16" x 12



45° swept tube female concave seat



Code	To suit hose	Thread
536-4504	536-04	JIC 7/16" x 20
536-4506	536-06	JIC 9/16" x 18
536-4508	536-08	JIC 3/4" x 16
536-4510	536-10	JIC 7/8" x 14
536-4512	536-12	JIC 1 1/16" x 12



90° swept tube female concave seat



Code	To suit hose	Thread
536-9004	536-04	JIC 7/16" x 20
536-9006	536-06	JIC 9/16" x 18
536-9008	536-08	JIC 3/4" x 16
536-9010	536-10	JIC 7/8" x 14
536-9012	536-12	JIC 1 1/16" x 12



120° swept tube female concave seat



Code	To suit hose	Thread
536-12004	536-04	JIC 7/16" x 20
536-12006	536-06	JIC 9/16" x 18
536-12008	536-08	JIC 3/4" x 16
536-12010	536-10	JIC 7/8" x 14
536-12012	536-12	JIC 1 1/16" x 12



150° swept tube female concave seat



Code	To suit hose	Thread
536-15004	536-04	JIC 7/16" x 20
536-15006	536-06	JIC 9/16" x 18
536-15008	536-08	JIC 3/4" x 16
536-15010	536-10	JIC 7/8" x 14
536-15012	536-12	JIC 1 1/16" x 12



180° swept tube female concave seat



Code	To suit hose	Thread
536-18004	536-04	JIC 7/16" x 20
536-18006	536-06	JIC 9/16" x 18
536-18008	536-08	JIC 3/4" x 16
536-18010	536-10	JIC 7/8" x 14
536-18012	536-12	JIC 1 1/16" x 12



Straight Female Concave Seat



Code	To suit hose	Thread
536-0104DBK	536-04	JIC 7/16" x 20
536-0106DBK	536-06	JIC 9/16" x 18
536-0108DBK	536-08	JIC 3/4" x 16
536-0110DBK	536-10	JIC 7/8" x 14
536-0112DBK	536-12	JIC 1 1/16" x 12



45° swept tube female concave seat



Code	To suit hose	Thread
536-4504DBK	536-04	JIC 7/16" x 20
536-4506DBK	536-06	JIC 9/16" x 18
536-4508DBK	536-08	JIC 3/4" x 16
536-4510DBK	536-10	JIC 7/8" x 14
536-4512DBK	536-12	JIC 1 1/16" x 12



90° swept tube female concave seat



Code	To suit hose	Thread
536-9004DBK	536-04	JIC 7/16" x 20
536-9006DBK	536-06	JIC 9/16" x 18
536-9008DBK	536-08	JIC 3/4" x 16
536-9010DBK	536-10	JIC 7/8" x 14
536-9012DBK	536-12	JIC 1 1/16" x 12



120° swept tube female concave seat



Code	To suit hose	Thread
536-12006DBK	536-06	JIC 9/16" x 18
536-12008DBK	536-08	JIC 3/4" x 16
536-12010DBK	536-10	JIC 7/8" x 14
536-12012DBK	536-12	JIC 1 1/16" x 12



150° swept tube female concave seat



Code	To suit hose	Thread
536-15006DBK	536-06	JIC 9/16" x 18
536-15008DBK	536-08	JIC 3/4" x 16
536-15010DBK	536-10	JIC 7/8" x 14
536-15012DBK	536-12	JIC 1 1/16" x 12



180° swept tube female concave seat



Code	To suit hose	Thread
536-18006DBK	536-06	JIC 9/16" x 18
536-18008DBK	536-08	JIC 3/4" x 16
536-18010DBK	536-10	JIC 7/8" x 14
536-18012DBK	536-12	JIC 1 1/16" x 12

Goodridge supply a range of stainless steel and aluminium hard line to suit high pressure applications. Often used in combination with flexi-hose to make up a complete hose assembly.

Stainless steel hard line is available in AN-03, ideal for brake and clutch systems.
 Aluminium hard line is available in AN-04 and AN-06, ideal for air jack, fuel, oil and water systems.
 A complete range of hard-line fittings are also available to suit each individual application.
 Please also see the 'adaptors' section for T-Pieces and adaptors.

Benefits:

- Uninterrupted flow
- Burst pressure up to 15228 PSI / 1050 BAR
- Bend radius to 15m

Features:

- Fitting range available
- Smooth bore
- Seamless



GOODRIDGE
 FLUID TRANSFER SYSTEMS
HL836 Steel

Goodridge HL836 AN-03 Stainless Steel hard line is ideal for brake and clutch applications. Constructed of cold drawn seamless Stainless Steel, the hard line gives consistent flares and non-collapsing bends. It is possible to flare the tube using a hand operated flaring tool.

Fluid applications:

Brake and clutch systems.

Material:

Seamless Stainless Steel

Notes:

Supplied in 3m lengths

Contact us for:

CNC formed assemblies

Mild steel (B1213) 'Bundy tube' and Cupronickel equivalents (K1213)

Code	Mat	Dash No	Bore size mm (in)	Wall thickness mm (in)	Nominal hose OD mm (in)	Working pressure BAR (PSI)	Burst pressure BAR (PSI)	Weight Kg/m (Lb/Ft)	Min. bend radius mm (in)
B1213	Mild Steel	-03	3,27 (0,128)	0,72 (0,028)	4,80 (0,189)	358 (5200)	1447 (21000)	0,071 (0,048)	5,00 (0,20)
HL836-03C	Stainless steel	-03	3,36 (0,133)	0,72 (0,028)	4,80 (0,189)	343 (5076)	1050 (15228)	0,071 (0,048)	7,20 (0,28)



GOODRIDGE
 FLUID TRANSFER SYSTEMS
HL836 Aluminium

Goodridge HL836 AN-04 and AN-06 Aluminium hard line is the ultimate lightweight hard-line solution; ideal for air jack, fuel, oil and water applications. The Hycot® tube is a corrosion resistant, light weight, precision drawn aluminium tube with a polyamide coating; providing strength and rigidity whilst allowing it to be formed to suit the installation.

HL 836 fitting design does not require the tube to be flared, in addition a range of banjo, tee-piece, male and female fittings to ease the installation of complex systems, in tight environments.

Fluid applications:

Air jack, Fuel, Oil and Water.

Material:

Aluminium

Notes:

Supplied in 4m lengths (Straight or coiled)

Contact us for:

CNC formed assemblies

Code	Mat	Dash No	Bore size mm (in)	Wall thickness mm (in)	Nominal hose OD mm (in)	Working pressure BAR (PSI)	Burst pressure BAR (PSI)	Weight Kg/m (Lb/Ft)	Min. bend radius mm (in)
HL836-04D	D	-04	6,04 (0,237)	1,00 (0,039)	8,04 (0,317)	95 (1378)	290 (4206)	0,059 (0,040)	16,00 (0,63)
HL836-06D	D	-06	8,04 (0,317)	1,00 (0,039)	10,04 (0,400)	95 (1378)	290 (4206)	0,070 (0,047)	20,00 (0,71)



GOODRIDGE
 FLUID TRANSFER SYSTEMS
Cupro-nickel

Fluid applications:

Brake and clutch systems.

Material:

Cupro-Nickel

Notes:

Supplied in 7.2m lengths (coiled)

Code	Mat	Dash No	Bore size mm (in)	Wall thickness mm (in)	Nominal hose OD mm (in)	Working pressure BAR (PSI)	Burst pressure BAR (PSI)	Weight Kg/m (Lb/Ft)	Min. bend radius mm (in)
K1213	Cupro-nickel	-03	3,34 (0,131)	0,71 (0,027)	4,76 (0,187)	215 (3120)	860 (12480)	0,071 (0,048)	7,14 (0,281)

FITTINGS

B: Brass - C: Stainless steel - CH: Chrome plated - D: Aluminium - P: Zinc plated carbon steel - Z1: Silver plated carbon steel

HL836 Stainless steel AN-03 fittings



Male tube nut



Code	To suit hose	Hole size	Thread	Mat
N8401	HL836-03C	-	M10 x 1,00 SHORT	P
N8402	HL836-03C	-	M10 x 1,00 LONG	P
N8412	HL836-03C	-	M12 x 1,00	P
N8426	HL836-03C	-	3/8 x 24	P
N8426C	HL836-03C	-	3/8 x 24	C
N8462	HL836-03C	-	7/16 x 20	P



Female tube nut (to be used with 819)



Code	To suit hose	Hole size	Thread	Mat
818-31C	HL836-03C	-	M10 x 1,00 mm	C
AN818-03C	HL836-03C	-	3/8 x 24	C



Tube sleeve (to be used with 818)



Code	To suit hose	Hole size	Thread	Mat
AN819-03C	HL836-03C	-	3/8" x 24	C



Female tube nut



Code	To suit hose	Hole size	Thread	Mat
N1401	HL836-03C	-	M10 x 1,00	P
N1406	HL836-03C	-	3/8 x 24	P
N1460	HL836-03C	-	7/16 x 20	P

HL836 Aluminium AN-04 & 06 JIC fittings



Straight female swivel



Code	To suit hose	Hole size	Thread	Mat
HL821-0406D	HL836-04D	-	9/16 x 18	D
HL821-04D	HL836-04D	-	7/16 x 20	D
HL821-06D	HL836-06D	-	9/16 x 18	D



45° female swivel



Code	To suit hose	Hole size	Thread	Mat
HL822-06D	HL836-06D	-	9/16 x 18	D



90° female swivel



Code	To suit hose	Hole size	Thread	Mat
HL823-04D	HL836-04D	-	7/16 x 20	D
HL823-06D	HL836-06D	-	9/16 x 18	D



Straight banjo



Code	To suit hose	Hole size	Thread	Mat
HL591-06D	HL836-06D	14,29 mm	9/16 x 18	D



Coupler



Code	To suit hose	Hole size	Thread	Mat
HL811-06D	HL836-06D	-	-	D



Tee piece



Code	To suit hose	Hole size	Thread	Mat
HL814-06D	HL836-06D	-	-	D



Tee piece with female swivel on the run



Code	To suit hose	Hole size	Thread	Mat
HL824-06D	HL836-06D	-	9/16 x 18	D



Tee piece with female swivel on leg



Code	To suit hose	Hole size	Thread	Mat
HL854-06D	HL836-06D	-	9/16 x 18	D

FITTINGS

B: Brass - C: Stainless steel - CH: Chrome plated - D: Aluminium - P: Zinc plated carbon steel - Z1: Silver plated carbon steel



Straight male



Code	To suit hose	Hole size	Thread	Mat
HL831-0406D	HL836-04D	-	9/16 x 18	D
HL831-06D	HL836-06D	-	9/16 x 18	D



45° male bulkhead



Code	To suit hose	Hole size	Thread	Mat
HL837-06D	HL836-06D	-	9/16 x 18	D



Replacement olive



Code	To suit hose	Hole size	Thread	Mat
1209-04D	HL836_04D	-	-	D
1209-06D	HL836_06D	-	-	D



Straight male bulkhead



Code	To suit hose	Hole size	Thread	Mat
HL841-06D	HL836-06D	-	9/16 x 18	D



90° male bulkhead



Code	To suit hose	Hole size	Thread	Mat
HL843-06D	HL836-06D	-	9/16 x 18	D



Replacement socket



Code	To suit hose	Hole size	Thread	Mat
1210-04D	HL836_04D	-	-	D
1210-06D	HL836_06D	-	-	D

i Airjack systems

836 series hose and fittings are suggested for airjack systems. For any advice or specific information, please contact us.



JIC TO JIC ADAPTORS

B: Brass - C: Stainless steel - CH: Chrome plated - D: Aluminium - P: Zinc plated carbon steel - Z1: Silver plated carbon steel

JIC to JIC equal thread
D = blue aluminium if not specified



Equal male



Code	Thread A	Thread B	Mat	Note
815-02C	5/16 x 24	-	C	-
815-03C	3/8 x 24	-	C	-
815-03CH	3/8 x 24	-	CH	-
815-03P	3/8 x 24	-	P	-
815-04C	7/16 x 20	-	C	-
815-04P	7/16 x 20	-	P	-
815-06P	9/16 x 18	-	P	-
815-08P	3/4 x 16	-	P	-
815-10P	7/8 x 14	-	P	-
815-12P	1 1/16 x 12	-	P	-
815-16P	1 5/16 x 12	-	P	-



Equal male



Code	Thread A	Thread B	Mat	Note
AN815-02D	5/16 x 24	-	D	-
AN815-03D	3/8 x 24	-	D	-
AN815-04D	7/16 x 20	-	D	-
AN815-04DBK	7/16 x 20	-	D	Black
AN815-05D	1/2 x 20	-	D	-
AN815-06D	9/16 x 18	-	D	-
AN815-06DBK	9/16 x 18	-	D	Black
AN815-08D	3/4 x 16	-	D	-
AN815-08DBK	3/4 x 16	-	D	Black
AN815-10D	7/8 x 14	-	D	-
AN815-10DBK	7/8 x 14	-	D	Black
AN815-12D	1 1/16 x 12	-	D	-
AN815-12DBK	1 1/16 x 12	-	D	Black
AN815-16D	1 5/16 x 12	-	D	-
AN815-16DBK	1 5/16 x 12	-	D	Black



Equal male convex-concave



Code	Thread A	Thread B	Mat	Note
815-03VC	3/8 x 24	-	C	-
815-03VCH	3/8 x 24	-	CH	-
815-03VP	3/8 x 24	-	P	-



90° elbow male



Code	Thread A	Thread B	Mat	Note
AN821-03C	3/8 x 24	-	C	-
AN821-03D	3/8 x 24	-	D	-
AN821-04D	7/16 x 20	-	D	-
AN821-06D	9/16 x 18	-	D	-
AN821-06DBK	9/16 x 18	-	D	Black
AN821-08D	3/4 x 16	-	D	-
AN821-08DBK	3/4 x 16	-	D	Black
AN821-10D	7/8 x 14	-	D	-
AN821-12D	1 1/16 x 12	-	D	-
AN821-16D	1 5/16 x 12	-	D	-



Male tee



Code	Thread A	Thread B	Mat	Note
AN824-03C	3/8 x 24	3/8 x 24	C	-
AN824-03D	3/8 x 24	3/8 x 24	D	-
AN824-04C	7/16 x 20	7/16 x 20	C	-
AN824-04D	7/16 x 20	7/16 x 20	D	-
AN824-04DBK	7/16 x 20	7/16 x 20	D	Black
AN824-06D	9/16 x 18	9/16 x 18	D	-
AN824-06DBK	9/16 x 18	9/16 x 18	D	Black
AN824-08D	3/4 x 16	3/4 x 16	D	-
AN824-08DBK	3/4 x 16	3/4 x 16	D	Black
AN824-10D	7/8 x 14	7/8 x 14	D	-
AN824-10DBK	7/8 x 14	7/8 x 14	D	Black
AN824-12D	1 1/16 x 12	1 1/16 x 12	D	-
AN824-12DBK	1 1/16 x 12	1 1/16 x 12	D	Black
AN824-16D	1 5/16 x 12	1 5/16 x 12	D	-



Male adaptor 4 ways



Code	Thread A	Thread B	Mat	Note
AN827-06D	9/16 x 18	-	D	-



Male bulkhead



Code	Thread A	Thread B	Mat	Note
832-03C	3/8 x 24	-	C	-
832-03P	3/8 x 24	-	P	-
832-04P	7/16 x 20	-	P	-
832-06P	9/16 x 18	-	P	-



Male bulkhead



Code	Thread A	Thread B	Mat	Note
AN832-03D	3/8 x 24	-	D	-
AN832-04C	7/16 x 20	-	C	-
AN832-04D	7/16 x 20	-	D	-
AN832-04DBK	7/16 x 20	-	D	Black
AN832-06D	9/16 x 18	-	D	-
AN832-06DBK	9/16 x 18	-	D	Black
AN832-08D	3/4 x 16	-	D	-
AN832-08DBK	3/4 x 16	-	D	Black
AN832-10D	7/8 x 14	-	D	-
AN832-10DBK	7/8 x 14	-	D	Black
AN832-12D	1 1/16 x 12	-	D	-
AN832-12DBK	1 1/16 x 12	-	D	Black
AN832-16D	1 5/16 x 12	-	D	-
AN832-16DBK	1 5/16 x 12	-	D	Black



45° male bulkhead



Code	Thread A	Thread B	Mat	Note
AN837-03D	3/8 x 24	-	D	-
AN837-04D	7/16 x 20	-	D	-
AN837-04DBK	7/16 x 20	-	D	Black
AN837-06D	9/16 x 18	-	D	-
AN837-06DBK	9/16 x 18	-	D	Black
AN837-08D	3/4 x 16	-	D	-
AN837-10D	7/8 x 14	-	D	-

JIC TO JIC ADAPTORS

B: Brass - C: Stainless steel - CH: Chrome plated - D: Aluminium - P: Zinc plated carbon steel - Z1: Silver plated carbon steel



90° male bulkhead



Code	Thread A	Thread B	Mat	Note
AN833-03C	3/8 x 24	-	C	-
AN833-03D	3/8 x 24	-	D	-
AN833-04C	7/16 x 20	-	C	-
AN833-04D	7/16 x 20	-	D	-
AN833-04DBK	7/16 x 20	-	D	Black
AN833-06D	9/16 x 18	-	D	-
AN833-06DBK	9/16 x 18	-	D	Black
AN833-08D	3/4 x 16	-	D	-
AN833-08DBK	3/4 x 16	-	D	Black
AN833-10D	7/8 x 14	-	D	-
AN833-12D	1 1/16 x 12	-	D	-
AN833-12DBK	1 1/16 x 12	-	D	Black
AN833-16D	1 5/16 x 12	-	D	-



Adaptor - bulkhead tee on run



Code	Thread A	Thread B	Mat	Note
AN804-03D	3/8 x 24	-	D	-
AN804-04D	7/16 x 20	-	D	-
AN804-06D	9/16 x 18	-	D	-
AN804-08D	3/4 x 16	-	D	-



Male bulkhead tee



Code	Thread A	Thread B	Mat	Note
AN834-03C	3/8 x 24	-	C	-
AN834-03D	3/8 x 24	-	D	-
AN834-04D	7/16 x 20	-	D	-
AN834-06D	9/16 x 18	-	D	-
AN834-06DBK	9/16 x 18	-	D	Black
AN834-08D	3/4 x 16	-	D	-
AN834-12D	1 1/16 x 12	-	D	-



Female tee



Code	Thread A	Thread B	Mat	Note
AN938-04D	7/16 x 20	-	D	-
AN938-06D	9/16 x 18	-	D	-
AN938-08D	3/4 x 16	-	D	-
AN938-10D	7/8 x 14	-	D	-
AN938-12D	1 1/16 x 12	-	D	-



Plug



Code	Thread A	Thread B	Mat	Note
AN806-03D	3/8 x 24	-	D	-
AN806-04D	7/16 x 20	-	D	-
AN806-04DBK	7/16 x 20	-	D	Black
AN806-06D	9/16 x 18	-	D	-
AN806-06DBK	9/16 x 18	-	D	Black
AN806-08D	3/4 x 16	-	D	-
AN806-08DBK	3/4 x 16	-	D	Black
AN806-10D	7/8 x 14	-	D	-
AN806-10DBK	7/8 x 14	-	D	Black
AN806-12D	1 1/16 x 12	-	D	-
AN806-12DBK	1 1/16 x 12	-	D	Black
AN806-16D	1 5/16 x 12	-	D	-
AN806-16DBK	1 5/16 x 12	-	D	Black



Port plug



Code	Thread A	Thread B	Mat	Note
AN814-03D	3/8 x 24	-	D	-
AN814-04D	7/16 x 20	-	D	-
AN814-04DBK	7/16 x 20	-	D	Black
AN814-06D	9/16 x 18	-	D	-
AN814-06DBK	9/16 x 18	-	D	Black
AN814-08D	3/4 x 16	-	D	-
AN814-08DBK	3/4 x 16	-	D	Black
AN814-10D	7/8 x 14	-	D	-
AN814-10DBK	7/8 x 14	-	D	Black
AN814-12D	1 1/16 x 12	-	D	-



Port plug



Code	Thread A	Thread B	Mat	Note
AN814-06SD	9/16 x 18	-	D	Socket Hex
AN814-03SD	3/8 x 24	-	D	-
AN814-04SD	7/16 x 20	-	D	-



Tube nut



Code	Thread A	Thread B	Mat	Note
AN818-03D	3/8 x 24	-	D	-
AN818-04D	7/16 x 20	-	D	-
AN818-06D	9/16 x 18	-	D	-



Cap



Code	Thread A	Thread B	Mat	Note
AN929-02D	5/16 x 24	-	D	-
AN929-03D	3/8 x 24	-	D	-
AN929-04D	7/16 x 20	-	D	-
AN929-04DBK	7/16 x 20	-	D	Black
AN929-05D	1/2 x 20	-	D	-
AN929-06D	9/16 x 18	-	D	-
AN929-06DBK	9/16 x 18	-	D	Black
AN929-08D	3/4 x 16	-	D	-
AN929-08DBK	3/4 x 16	-	D	Black
AN929-10D	7/8 x 14	-	D	-
AN929-10DBK	7/8 x 14	-	D	Black
AN929-12D	1 1/16 x 12	-	D	-
AN929-12DBK	1 1/16 x 12	-	D	Black
AN929-16D	1 5/16 x 12	-	D	-
AN929-16DBK	1 5/16 x 12	-	D	Black
AN929-20D	1 5/8 x 12	-	D	-
AN929-20DBK	1 5/8 x 12	-	D	Black

JIC TO JIC ADAPTORS

B: Brass - C: Stainless steel - CH: Chrome plated - D: Aluminium - P: Zinc plated carbon steel - Z1: Silver plated carbon steel



Nut



Code	Thread A	Thread B	Mat	Note
AN924-03D	3/8 x 24	-	D	-
AN924-04C	7/16 x 20	-	C	-
AN924-04D	7/16 x 20	-	D	-
AN924-04DBK	7/16 x 20	-	D	Black
AN924-06D	9/16 x 18	-	D	-
AN924-06DBK	9/16 x 18	-	D	Black
AN924-08D	3/4 x 16	-	D	-
AN924-08DBK	3/4 x 16	-	D	Black
AN924-10D	7/8 x 14	-	D	-
AN924-10DBK	7/8 x 14	-	D	Black
AN924-12D	1 1/16 x 12	-	D	-
AN924-12DBK	1 1/16 x 12	-	D	Black
AN924-16D	1 5/16 x 12	-	D	-
AN924-16DBK	1 5/16 x 12	-	D	Black



Tube sleeve



Code	Thread A	Thread B	Mat	Note
AN819-03D	-	-	D	For use with AN818-03
AN819-04D	-	-	D	For use with AN818-04
AN819-06D	-	-	D	For use with AN818-06



Male weld flange adaptor



Code	Thread A	Thread B	Mat	Note
AN971-04D	7/16 x 20	-	D	-
AN971-06D	9/16 x 18	-	D	-
AN971-08D	3/4 x 16	-	D	-
AN971-10D	7/8 x 14	-	D	-
AN971-12D	1 1/16 x 12	-	D	-
AN971-16D	1 5/16 x 12	-	D	-
AN971-20D	1 5/8 x 12	-	D	-



Adaptor weld female



Code	Thread A	Thread B	Mat	Note
AN871-04D	7/16 x 20	-	D	-
AN871-06D	9/16 x 18	-	D	-
AN871-08D	3/4 x 16	-	D	-
AN871-10D	7/8 x 14	-	D	-
AN871-12D	1 1/16 x 12	-	D	-

JIC to JIC unequal thread
D=blue aluminium if not specified



Adaptor - male to male



Code	Thread A	Thread B	Mat	Note
919-04-03C	7/16 x 20	3/8 x 24	C	-
919-04-03P	7/16 x 20	3/8 x 24	P	-
919-04-44P	7/16 x 20	7/16 x 24	P	-
919-06-03D	9/16 x 18	3/8 x 24	D	-
919-06-04P	9/16 x 18	7/16 x 20	P	-
919-08-06P	3/4 x 16	9/16 x 18	P	-
919-10-06P	7/8 x 14	9/16 x 18	P	-
919-10-08P	7/8 x 14	3/4 x 16	P	-
919-12-10P	1 1/16 x 12	7/8 x 14	P	-



Male to male



Code	Thread A	Thread B	Mat	Note
AN919-02D	3/8 x 24	7/16 x 20	D	-
AN919-02DBK	3/8 x 24	7/16 x 20	D	Black
AN919-03D	7/16 x 20	1/2 x 20	D	-
AN919-06D	9/16 x 18	7/16 x 20	D	-
AN919-06DBK	9/16 x 18	7/16 x 20	D	Black
AN919-07D	9/16 x 18	1/2 x 20	D	-
AN919-10D	3/4 x 16	7/16 x 20	D	-
AN919-10DBK	3/4 x 16	7/16 x 20	D	Black
AN919-12D	9/16 x 18	3/4 x 16	D	-
AN919-12DBK	9/16 x 18	3/4 x 16	D	Black
AN919-14D	7/8 x 14	9/16 x 18	D	-
AN919-14DBK	7/8 x 14	9/16 x 18	D	Black
AN919-15D	7/8 x 14	3/4 x 16	D	-
AN919-18D	1 1/16 x 12	9/16 x 18	D	-
AN919-19D	1 1/16 x 12	3/4 x 16	D	-
AN919-19DBK	1 1/16 x 12	3/4 x 16	D	Black
AN919-20D	1 1/16 x 12	7/8 x 14	D	-
AN919-20DBK	1 1/16 x 12	7/8 x 14	D	Black
AN919-22D	1 5/16 x 12	7/8 x 14	D	-
AN919-23D	1 5/16 x 12	1 1/16 x 12	D	-
AN919-23DBK	1 5/16 x 12	1 1/16 x 12	D	Black



Tee with unequal leg



Code	Thread A	Thread B	Mat	Note
AN824-06-06-08D	9/16 x 18	3/4 x 16	D	-

JIC Male to female unequal thread
D=blue aluminium if not specified



Male to female adaptor (JIC seats) reducer



Code	Thread A	Thread B	Mat	Note
AN950-04-03D	7/16 x 20	3/8 x 24	D	-
AN950-06-03D	9/16 x 18	3/8 x 24	D	-
AN950-06-04D	9/16 x 18	7/16 x 20	D	-
AN950-08-04D	3/4 x 16	7/16 x 20	D	-
AN950-08-06D	3/4 x 16	9/16 x 18	D	-
AN950-08-06DBK	3/4 x 16	9/16 x 18	D	Black
AN950-10-06D	7/8 x 14	9/16 x 18	D	-
AN950-10-06DBK	7/8 x 14	9/16 x 18	D	Black
AN950-10-08D	7/8 x 14	3/4 x 16	D	-
AN950-10-08DBK	7/8 x 14	3/4 x 16	D	Black
AN950-12-08D	1 1/16 x 12	3/4 x 16	D	-
AN950-12-08DBK	1 1/16 x 12	3/4 x 16	D	Black
AN950-12-10D	1 1/16 x 12	7/8 x 14	D	-
AN950-12-10DBK	1 1/16 x 12	7/8 x 14	D	Black
AN950-16-12D	1 5/16 x 12	1 1/16 x 12	D	-



female - male expander



Code	Thread A	Thread B	Mat	Note
AN951-03-04C	3/8 x 24	7/16 x 20	C	-
AN951-03-04D	3/8 x 24	7/16 x 20	D	-
AN951-03-04DBK	3/8 x 24	7/16 x 20	D	Black
AN951-04-06D	7/16 x 20	9/16 x 18	D	-
AN951-04-06DBK	7/16 x 20	9/16 x 18	D	Black
AN951-06-08D	9/16 x 18	3/4 x 16	D	-
AN951-06-08DBK	9/16 x 18	3/4 x 16	D	Black
AN951-08-10D	3/4 x 16	7/8 x 14	D	-
AN951-08-10DBK	3/4 x 16	7/8 x 14	D	Black
AN951-10-12D	7/8 x 14	1 1/16 x 12	D	-
AN951-10-12DBK	7/8 x 14	1 1/16 x 12	D	Black
AN951-12-16D	1 1/16 x 12	1 5/16 x 12	D	-

JIC TO JIC ADAPTORS

B: Brass - C: Stainless steel - CH: Chrome plated - D: Aluminium - P: Zinc plated carbon steel - Z1: Silver plated carbon steel

Special Adaptors (inc modified AN parts for motorsport requirements)



Adaptor swivel female coupling



Code	Thread A	Thread B	Mat	Note
CPL-03C	3/8 x 24	-	C	-
CPL-03D	3/8 x 24	-	D	-
CPL-04C	7/16 x 20	-	C	-
CPL-04D	7/16 x 20	-	D	-
CPL-04DBK	7/16 x 20	-	D	Black
CPL-06D	9/16 x 18	-	D	-
CPL-06DBK	9/16 x 18	-	D	Black
CPL-08D	3/4 x 16	-	D	-
CPL-08DBK	3/4 x 16	-	D	Black
CPL-10D	7/8 x 14	-	D	-
CPL-10DBK	7/8 x 14	-	D	Black
CPL-12D	1 1/16 x 12	-	D	-
CPL-12DBK	1 1/16 x 12	-	D	Black
CPL-16D	1 5/16 x 12	-	D	-
CPL-16DBK	1 5/16 x 12	-	D	Black



Adaptor tee male thread on run swivel female on leg



Code	Thread A	Thread B	Mat	Note
CPL-824-03D	3/8 x 24	-	D	-
CPL-824-04D	7/16 x 20	-	D	-
CPL-824-04DBK	7/16 x 20	-	D	Black
CPL-824-06D	9/16 x 18	-	D	-
CPL-824-06DBK	9/16 x 18	-	D	Black
CPL-824-08D	3/4 x 16	-	D	-
CPL-824-08DBK	3/4 x 16	-	D	Black
CPL-824-10D	7/8 x 14	-	D	-
CPL-824-12D	1 1/16 x 12	-	D	-
CPL-824-12DBK	1 1/16 x 12	-	D	Black



Adaptor 90° male to female swivel



Code	Thread A	Thread B	Mat	Note
CPL-903C	3/8 x 24	-	C	-
CPL-903D	3/8 x 24	-	D	-
CPL-904D	7/16 x 20	-	D	-
CPL-904DBK	7/16 x 20	-	D	Black
CPL-906D	9/16 x 18	-	D	-
CPL-906DBK	9/16 x 18	-	D	Black
CPL-908D	3/4 x 16	-	D	-
CPL-908DBK	3/4 x 16	-	D	Black
CPL-910D	7/8 x 14	-	D	-
CPL-912D	1 1/16 x 12	-	D	-



Adaptor 45° male to swivel female



Code	Thread A	Thread B	Mat	Note
CPL-823-03C	3/8 x 24	-	C	-
CPL-823-03D	3/8 x 24	-	D	-
CPL-823-04D	7/16 x 20	-	D	-
CPL-823-06D	9/16 x 18	-	D	-
CPL-823-06DBK	9/16 x 18	-	D	Black
CPL-823-08D	3/4 x 16	-	D	-
CPL-823-10D	7/8 x 14	-	D	-
CPL-823-12D	1 1/16 x 12	-	D	-



Adaptor tee swivel female on run



Code	Thread A	Thread B	Mat	Note
CPL-826-03D	3/8 x 24	-	D	-
CPL-826-04D	7/16 x 20	-	D	-
CPL-826-04DBK	7/16 x 20	-	D	Black
CPL-826-06D	9/16 x 18	-	D	-
CPL-826-06DBK	9/16 x 18	-	D	Black
CPL-826-08D	3/4 x 16	-	D	-
CPL-826-10D	7/8 x 14	-	D	-
CPL-826-10DBK	7/8 x 14	-	D	Black
CPL-826-12D	1 1/16 x 12	-	D	-
CPL-826-12DBK	1 1/16 x 12	-	D	Black
CPL-826-16D	1 5/16 x 12	-	D	-



Adaptor 90° female to female swivel



Code	Thread A	Thread B	Mat	Note
CPL-9104	7/16 x 20	-	D	-
CPL-9104BK	7/16 x 20	-	D	Black
CPL-9106	9/16 x 18	-	D	-
CPL-9106BK	9/16 x 18	-	D	Black
CPL-9108	3/4 x 16	-	D	-
CPL-9108BK	3/4 x 16	-	D	Black
CPL-9110	7/8 x 14	-	D	-
CPL-9110BK	7/8 x 14	-	D	Black
CPL-9112	1 1/16 x 12	-	D	-
CPL-9116	1 5/16 x 12	-	D	-



Adaptor 90° female to female swivel



Code	Thread A	Thread B	Mat	Note
CPL-9004	7/16 x 20	-	D	-
CPL-9004BK	7/16 x 20	-	D	Black
CPL-9006	9/16 x 18	-	D	-
CPL-9006BK	9/16 x 18	-	D	Black
CPL-9008	3/4 x 16	-	D	-
CPL-9008BK	3/4 x 16	-	D	Black
CPL-9010	7/8 x 14	-	D	-
CPL-9012	1 1/16 x 12	-	D	-



JIC TO NPT MALE TO MALE ADAPTORS

B: Brass - C: Stainless steel - CH: Chrome plated - D: Aluminium - P: Zinc plated carbon steel - Z1: Silver plated carbon steel



Adaptor straight male JIC to straight male NPT



Code	Thread A	Thread B	Mat	Note
816-03-04P	3/8 x 24	NPT 1/4" x 18	P	-
816-03C	3/8 x 24	NPT 1/8" x 27	C	-
816-03CH	3/8 x 24	NPT 1/8" x 27	CH	-
816-03P	3/8 x 24	NPT 1/8" x 27	P	-
816-04-04P	7/16 x 20	NPT 1/4" x 18	P	-
816-04P	7/16 x 20	NPT 1/8" x 27	P	-



Adaptor straight male JIC to straight male NPT



Code	Thread A	Thread B	Mat	Note
AN816-03-04D	3/8 x 24	NPT 1/4" x 18	D	-
AN816-03D	3/8 x 24	NPT 1/8" x 27	D	-
AN816-04-04D	7/16 x 20	NPT 1/4" x 18	D	-
AN816-04-04DBK	7/16 x 20	NPT 1/4" x 18	D	Black
AN816-04-06D	7/16 x 20	NPT 3/8" x 18	D	-
AN816-04C	7/16 x 20	NPT 1/8" x 27	C	-
AN816-04D	7/16 x 20	NPT 1/8" x 27	D	-
AN816-04DBK	7/16 x 20	NPT 1/8" x 27	D	Black
AN816-06-02D	9/16 x 18	NPT 1/8" x 27	D	-
AN816-06-02DBK	9/16 x 18	NPT 1/8" x 27	D	Black
AN816-06-06D	9/16 x 18	NPT 3/8" x 18	D	-
AN816-06-06DBK	9/16 x 18	NPT 3/8" x 18	D	Black
AN816-06-08D	9/16 x 18	NPT 1/2" x 14	D	-
AN816-06-08DBK	9/16 x 18	NPT 1/2" x 14	D	Black

Code	Thread A	Thread B	Mat	Note
AN816-06D	9/16 x 18	NPT 1/4" x 18	D	-
AN816-06DBK	9/16 x 18	NPT 1/4" x 18	D	Black
AN816-07D	3/4 x 16	NPT 1/4" x 18	D	-
AN816-07DBK	3/4 x 16	NPT 1/4" x 18	D	Black
AN816-08-08D	3/4 x 16	NPT 1/2" x 14	D	-
AN816-08-08DBK	3/4 x 16	NPT 1/2" x 14	D	Black
AN816-08-12D	3/4 x 16	NPT 3/4" x 14	D	-
AN816-08-12DBK	3/4 x 16	NPT 3/4" x 14	D	Black
AN816-08D	3/4 x 16	NPT 3/8" x 18	D	-
AN816-08DBK	3/4 x 16	NPT 3/8" x 18	D	Black
AN816-10-06D	7/8 x 14	NPT 3/8" x 18	D	-
AN816-10-06DBK	7/8 x 14	NPT 3/8" x 18	D	Black
AN816-10-12D	7/8 x 14	NPT 3/4" x 14	D	-
AN816-10D	7/8 x 14	NPT 1/2" x 14	D	-
AN816-10DBK	7/8 x 14	NPT 1/2" x 14	D	Black
AN816-12-08D	1 1/16 x 12	NPT 1/2" x 14	D	-
AN816-12-08DBK	1 1/16 x 12	NPT 1/2" x 14	D	Black
AN816-12D	1 1/16 x 12	NPT 3/4" x 14	D	-
AN816-12DBK	1 1/16 x 12	NPT 3/4" x 14	D	Black
AN816-16-12D	1 5/16 x 12	NPT 3/4" x 14	D	-
AN816-16D	1 5/16 x 12	NPT 1 x 11 1/2	D	-
AN816-16DBK	1 5/16 x 12	NPT 1 x 11 1/2	D	Black

Code	Thread A	Thread B	Mat	Note
AN822-04DBK	7/16 x 20	NPT 1/8" x 27	D	Black
AN822-06-02D	9/16 x 18	NPT 1/8" x 27	D	-
AN822-06-02DBK	9/16 x 18	NPT 1/8" x 27	D	Black
AN822-06-06D	9/16 x 18	NPT 3/8" x 18	D	-
AN822-06-06DBK	9/16 x 18	NPT 3/8" x 18	D	Black
AN822-06-08D	9/16 x 18	NPT 1/2" x 14	D	-
AN822-06D	9/16 x 18	NPT 1/4" x 18	D	-
AN822-06DBK	9/16 x 18	NPT 1/4" x 18	D	Black
AN822-07D	3/4 x 16	NPT 1/4" x 18	D	-
AN822-07DBK	3/4 x 16	NPT 1/4" x 18	D	Black
AN822-08-08D	3/4 x 16	NPT 1/2" x 14	D	-
AN822-08-12D	3/4 x 16	NPT 3/4" x 14	D	-
AN822-08D	3/4 x 16	NPT 3/8" x 18	D	-
AN822-08DBK	3/4 x 16	NPT 3/8" x 18	D	Black
AN822-10D	7/8 x 14	NPT 1/2" x 14	D	-
AN822-12-08D	1 1/16 x 12	NPT 1/2" x 14	D	-
AN822-12D	1 1/16 x 12	NPT 3/4" x 14	D	-
AN822-16D	1 5/16 x 12	NPT 1 x 11 1/2	D	-



45° male elbow JIC to NPT male



90° male elbow JIC to male NPT



Code	Thread A	Thread B	Mat	Note
AN822-03D	3/8 x 24	NPT 1/8" x 27	D	-
AN822-04-04D	7/16 x 20	NPT 1/4" x 18	D	-
AN822-04D	7/16 x 20	NPT 1/8" x 27	D	-

Code	Thread A	Thread B	Mat	Note
AN823-03D	3/8 x 24	NPT 1/8" x 27	D	-
AN823-04D	7/16 x 20	NPT 1/8" x 27	D	-
AN823-06-06D	9/16 x 18	NPT 3/8" x 18	D	-
AN823-06D	9/16 x 18	NPT 1/4" x 18	D	-
AN823-08-08D	3/4 x 16	NPT 1/2" x 14	D	-
AN823-08D	3/4 x 16	NPT 3/8" x 18	D	-
AN823-10-06D	7/8 x 14	NPT 3/8" x 18	D	-
AN823-10D	7/8 x 14	NPT 1/2" x 14	D	-
AN823-16D	1 5/16 x 12	NPT 1 x 11 1/2	D	-

NPT ADAPTORS



90° adaptor NPT to tube



Code	Thread	Mat
AN842-04D	1/8 x 27 for 200-04 hose	D
AN842-06D	1/4 x 18 for 200-06 hose	D
AN842-08D	3/8 x 18 for 200-08 hose	D
AN842-10D	1/2 x 14 for 200-10 hose	D
AN842-12D	3/4 x 14 for 200-12 hose	D



45° adaptor NPT to tube



Code	Thread	Mat
AN844-04D	1/8 x 27 for 200-04 hose	D
AN844-06D	1/4 x 18 for 200-06 hose	D
AN844-08D	3/8 x 18 for 200-08 hose	D



Plug socket head



Code	Thread	Mat
AN932-01D	NPT 1/16" x 27	D
AN932-02D	NPT 1/8" x 27	D

AN932 - follows

Code	Thread	Mat
AN932-03D	NPT 1/4" x 18	D
AN932-04D	NPT 3/8" x 18	D
AN932-05D	NPT 1/2" x 14	D
AN932-06D	NPT 3/4" x 14	D



Straight adaptor NPT to tube



Code	Thread	Mat
AN840-04D	1/8 x 27 for 200-04 hose	D
AN840-06D	1/4 x 18 for 200-06 hose	D
AN840-08D	3/8 x 18 for 200-08 hose	D
AN840-10D	1/2 x 14 for 200-10 hose	D
AN840-12D	3/4 x 14 for 200-12 hose	D

JIC MALE TO METRIC MALE ADAPTORS

B: Brass - C: Stainless steel - CH: Chrome plated - D: Aluminium - P: Zinc plated carbon steel - Z1: Silver plated carbon steel



Adaptor JIC to metric convex



Code	Thread A	Thread B	Mat	Note
305-03-21C	3/8 x 24	M8 x 1,00	C	-
305-03-31C	3/8 x 24	M10 x 1,00	C	-
305-03-31CBK	3/8 x 24	M10 x 1,00	C	Black
305-03-31CH	3/8 x 24	M10 x 1,00	CH	-
305-03-31D	3/8 x 24	M10 x 1,00	D	-
305-03-31Z1	3/8 x 24	M10 x 1,00	Z1	-
305-03-32C	3/8 x 24	M10 x 1,25	C	-
305-03-32Z1	3/8 x 24	M10 x 1,25	Z1	-
305-03-35Z1	3/8 x 24	M10 x 1,50	Z1	-
305-03-M121C	3/8 x 24	M12 x 1,00	C	-
305-03-M121Z1	3/8 x 24	M12 x 1,00	Z1	-
305-03-M122Z1	3/8 x 24	M12 x 1,25	Z1	-
305-03-M12C	3/8 x 24	M12 x 1,50	C	-
305-04-31D	7/16 x 20	M10 x 1,00	D	-
305-04-31DBK	7/16 x 20	M10 x 1,00	D	Black
305-04-31Z1	7/16 x 20	M10 x 1,00	Z1	-
305-04-32C	7/16 x 20	M10 x 1,25	C	-
305-04-35Z1	7/16 x 20	M10 x 1,50	Z1	-
305-04-M121Z1	7/16 x 20	M12 x 1,00	Z1	-
305-04-M122Z1	7/16 x 20	M12 x 1,25	Z1	-
305-04-M12D	7/16 x 20	M12 x 1,50	D	-
305-04-M12DBK	7/16 x 20	M12 x 1,50	D	Black
305-06-31D	9/16 x 18	M10 x 1,00	D	-
305-06-31DBK	9/16 x 18	M10 x 1,00	D	Black
305-06-M121D	9/16 x 18	M12 x 1,00	D	-
305-06-M121DBK	9/16 x 18	M12 x 1,00	D	Black
305-06-M122D	9/16 x 18	M12 x 1,25	D	-
305-06-M122DBK	9/16 x 18	M12 x 1,25	D	Black
305-06-M12D	9/16 x 18	M12 x 1,50	D	-
305-06-M12DBK	9/16 x 18	M12 x 1,50	D	Black
305-06-M14D	9/16 x 18	M14 x 1,50	D	-
305-06-M14DBK	9/16 x 18	M14 x 1,50	D	Black
305-06-M16D	9/16 x 18	M16 x 1,50	D	-
305-06-M16DBK	9/16 x 18	M16 x 1,50	D	Black
305-08-M12D	3/4 x 16	M12 x 1,50	D	-
305-08-M14D	3/4 x 16	M14 x 1,50	D	-
305-08-M14DBK	3/4 x 16	M14 x 1,50	D	Black
305-08-M16D	3/4 x 16	M16 x 1,50	D	-
305-08-M16DBK	3/4 x 16	M16 x 1,50	D	Black
305-10-M18D	7/8 x 14	M18 x 1,50	D	-
305-10-M18DBK	7/8 x 14	M18 x 1,50	D	Black



Adaptor JIC to metric concave



Code	Thread A	Thread B	Mat	Note
306-02-31C	5/16 x 24	M10 x 1,00	C	-
306-03-21C	3/8 x 24	M8 x 1,00	C	-
306-03-22C	3/8 x 24	M8 x 1,25	C	-
306-03-31C	3/8 x 24	M10 x 1,00	C	-
306-03-31CH	3/8 x 24	M10 x 1,00	CH	-
306-03-31D	3/8 x 24	M10 x 1,00	D	-
306-03-31DBK	3/8 x 24	M10 x 1,00	D	Black
306-03-31SZ1	3/8 x 24	M10 x 1,00	Z1	Short
306-03-31Z1	3/8 x 24	M10 x 1,00	Z1	-
306-03-32C	3/8 x 24	M10 x 1,25	C	-
306-03-32CH	3/8 x 24	M10 x 1,25	CH	-
306-03-32D	3/8 x 24	M10 x 1,25	D	-
306-03-32Z1	3/8 x 24	M10 x 1,25	Z1	-
306-03-35Z1	3/8 x 24	M10 x 1,50	Z1	-
306-03-M121D	3/8 x 24	M12 x 1,00	D	-
306-03-M12C	3/8 x 24	M12 x 1,50	C	-
306-03-M12D	3/8 x 24	M12 x 1,50	D	-
306-03-M16D	3/8 x 24	M16 x 1,50	D	-
306-04-31C	7/16 x 20	M10 x 1,00	C	-
306-04-31D	7/16 x 20	M10 x 1,00	D	-
306-04-31DBK	7/16 x 20	M10 x 1,00	D	Black
306-04-32D	7/16 x 20	M10 x 1,25	D	-
306-04-32DBK	7/16 x 20	M10 x 1,25	D	Black
306-04-35Z1	7/16 x 20	M10 x 1,50	D	-
306-04-M121D	7/16 x 20	M12 x 1,00	D	-
306-04-M121DBK	7/16 x 20	M12 x 1,00	D	Black
306-04-M12Z1	7/16 x 20	M12 x 1,50	Z1	-
306-04-M14D	7/16 x 20	M14 x 1,50	D	-
306-04-M14DBK	7/16 x 20	M14 x 1,50	D	Black
306-04-M14P	7/16 x 20	M14 x 1,50	P	-
306-04-M16Z1	7/16 x 20	M16 x 1,50	Z1	-
306-04-M18D	7/16 x 20	M18 x 1,50	D	-
306-04-M18DBK	7/16 x 20	M18 x 1,50	D	Black
306-06-31D	9/16 x 18	M10 x 1,00	D	-
306-06-31DBK	9/16 x 18	M10 x 1,00	D	Black
306-06-32D	9/16 x 18	M10 x 1,25	D	-
306-06-32DBK	9/16 x 18	M10 x 1,25	D	Black
306-06-M121D	9/16 x 18	M12 x 1,00	D	-
306-06-M121DBK	9/16 x 18	M12 x 1,00	D	Black
306-06-M12D	9/16 x 18	M12 x 1,50	D	-
306-06-M12DBK	9/16 x 18	M12 x 1,50	D	Black
306-06-M12Z1	9/16 x 18	M12 x 1,50	Z1	-
306-06-M14D	9/16 x 18	M14 x 1,50	D	-
306-06-M14DBK	9/16 x 18	M14 x 1,50	D	Black
306-06-M14Z1	9/16 x 18	M14 x 1,50	Z1	-
306-06-M16D	9/16 x 18	M16 x 1,50	D	-
306-06-M16DBK	9/16 x 18	M16 x 1,50	D	Black
306-06-M16Z1	9/16 x 18	M16 x 1,50	Z1	-
306-06-M18D	9/16 x 18	M18 x 1,50	D	-
306-06-M18DBK	9/16 x 18	M18 x 1,50	D	Black
306-06-M18Z1	9/16 x 18	M18 x 1,50	Z1	-
306-06-M20D	9/16 x 18	M20 x 1,50	D	-
306-06-M20DBK	9/16 x 18	M20 x 1,50	D	Black
306-06-M22D	9/16 x 18	M22 x 1,50	D	-
306-06-M22DBK	9/16 x 18	M22 x 1,50	D	Black
306-08-M12D	3/4 x 16	M12 x 1,50	D	-
306-08-M12DBK	3/4 x 16	M12 x 1,50	D	Black
306-08-M14D	3/4 x 16	M14 x 1,50	D	-

Code	Thread A	Thread B	Mat	Note
306-08-M14DBK	3/4 x 16	M14 x 1,50	D	Black
306-08-M14P	3/4 x 16	M14 x 1,50	P	-
306-08-M16D	3/4 x 16	M16 x 1,50	D	-
306-08-M16DBK	3/4 x 16	M16 x 1,50	D	Black
306-08-M16Z1	3/4 x 16	M16 x 1,50	Z1	-
306-08-M18D	3/4 x 16	M18 x 1,50	D	-
306-08-M18DBK	3/4 x 16	M18 x 1,50	D	Black
306-08-M18Z1	3/4 x 16	M18 x 1,50	Z1	-
306-08-M20D	3/4 x 16	M20 x 1,50	D	-
306-08-M20DBK	3/4 x 16	M20 x 1,50	D	Black
306-08-M22D	3/4 x 16	M22 x 1,50	D	-
306-08-M22DBK	3/4 x 16	M22 x 1,50	D	Black
306-08-M24D	3/4 x 16	M24 x 1,50	D	-
306-10-M14D	7/8 x 14	M14 x 1,50	D	-
306-10-M14DBK	7/8 x 14	M14 x 1,50	D	Black
306-10-M16D	7/8 x 14	M16 x 1,50	D	-
306-10-M16DBK	7/8 x 14	M16 x 1,50	D	Black
306-10-M16Z1	7/8 x 14	M16 x 1,50	Z1	-
306-10-M18D	7/8 x 14	M18 x 1,50	D	-
306-10-M18DBK	7/8 x 14	M18 x 1,50	D	Black
306-10-M20D	7/8 x 14	M20 x 1,50	D	-
306-10-M20DBK	7/8 x 14	M20 x 1,50	D	Black
306-10-M22D	7/8 x 14	M22 x 1,50	D	-
306-10-M22DBK	7/8 x 14	M22 x 1,50	D	Black
306-10-M24D	7/8 x 14	M24 x 1,50	D	-
306-10-M24DBK	7/8 x 14	M24 x 1,50	D	Black
306-10-M26D	7/8 x 14	M26 x 1,50	D	-
306-10-M26DBK	7/8 x 14	M26 x 1,50	D	Black
306-12-M18D	1 1/16 x 12	M18 x 1,50	D	-
306-12-M18DBK	1 1/16 x 12	M18 x 1,50	D	Black
306-12-M20D	1 1/16 x 12	M20 x 1,50	D	-
306-12-M20DBK	1 1/16 x 12	M20 x 1,50	D	Black
306-12-M22D	1 1/16 x 12	M22 x 1,50	D	-
306-12-M22DBK	1 1/16 x 12	M22 x 1,50	D	Black
306-12-M24D	1 1/16 x 12	M24 x 1,50	D	-
306-12-M24DBK	1 1/16 x 12	M24 x 1,50	D	Black
306-12-M26D	1 1/16 x 12	M26 x 1,50	D	-
306-12-M26DBK	1 1/16 x 12	M26 x 1,50	D	Black
306-12-M30D	1 1/16 x 12	M30 x 1,50	D	-
306-12-M30DBK	1 1/16 x 12	M30 x 1,50	D	Black
306-16-M26D	1 5/16 x 12	M26 x 1,50	D	-
306-16-M30D	1 5/16 x 12	M30 x 1,50	D	-



Adaptor JIC to metric convex bulkhead



Code	Thread A	Thread B	Mat	Note
307-03-31C	3/8 x 24	M10 x 1,00	C	Use locknut 318



BSP (GAS) TO JIC ADAPTORS

B: Brass - C: Stainless steel - CH: Chrome plated - D: Aluminium - P: Zinc plated carbon steel - Z1: Silver plated carbon steel



741

BSP male to JIC male



Code	Thread A	Thread B	Mat	Note
741-03-03D	BSP 1/8" x 28	3/8 x 24	D	-
741-03-03Z1	BSP 1/8" x 28	3/8 x 24	Z1	-
741-03-04D	BSP 1/8" x 28	7/16 x 20	D	-
741-03-04DBK	BSP 1/8" x 28	7/16 x 20	D	Black
741-03-04Z1	BSP 1/8" x 28	7/16 x 20	Z1	-
741-03-06D	BSP 1/8" x 28	9/16 x 18	D	-
741-03-06DBK	BSP 1/8" x 28	9/16 x 18	D	Black
741-04-03D	BSP 1/4" x 19	3/8 x 24	D	-
741-04-03DBK	BSP 1/4" x 19	3/8 x 24	D	Black
741-04-03Z1	BSP 1/4" x 19	3/8 x 24	Z1	-
741-04-04D	BSP 1/4" x 19	7/16 x 20	D	-
741-04-04DBK	BSP 1/4" x 19	7/16 x 20	D	Black
741-04-04Z1	BSP 1/4" x 19	7/16 x 20	Z1	-
741-04-06D	BSP 1/4" x 19	9/16 x 18	D	-
741-04-06DBK	BSP 1/4" x 19	9/16 x 18	D	Black
741-04-06Z1	BSP 1/4" x 19	9/16 x 18	Z1	-
741-04-08P	BSP 1/4" x 19	3/4 x 16	P	-
741-04-10P	BSP 1/4" x 19	7/8 x 14	P	-

Code	Thread A	Thread B	Mat	Note
741-06-04D	BSP 3/8" x 19	7/16 x 20	D	-
741-06-04DBK	BSP 3/8" x 19	7/16 x 20	D	Black
741-06-04Z1	BSP 3/8" x 19	7/16 x 20	Z1	-
741-06-06D	BSP 3/8" x 19	9/16 x 18	D	-
741-06-06DBK	BSP 3/8" x 19	9/16 x 18	D	Black
741-06-06Z1	BSP 3/8" x 19	9/16 x 18	Z1	-
741-06-08D	BSP 3/8" x 19	3/4 x 16	D	-
741-06-08DBK	BSP 3/8" x 19	3/4 x 16	D	Black
741-06-08Z1	BSP 3/8" x 19	3/4 x 16	Z1	-
741-06-10D	BSP 3/8" x 19	7/8 x 14	D	-
741-06-10DBK	BSP 3/8" x 19	7/8 x 14	D	Black
741-08-06D	BSP 1/2" x 14	9/16 x 18	D	-
741-08-06DBK	BSP 1/2" x 14	9/16 x 18	D	Black
741-08-06Z1	BSP 1/2" x 14	9/16 x 18	Z1	-
741-08-08D	BSP 1/2" x 14	3/4 x 16	D	-
741-08-08DBK	BSP 1/2" x 14	3/4 x 16	D	Black
741-08-08Z1	BSP 1/2" x 14	3/4 x 16	Z1	-
741-08-10D	BSP 1/2" x 14	7/8 x 14	D	-
741-08-10DBK	BSP 1/2" x 14	7/8 x 14	D	Black
741-08-10Z1	BSP 1/2" x 14	7/8 x 14	Z1	-
741-08-12D	BSP 1/2" x 14	1 1/16 x 12	D	-
741-08-12DBK	BSP 1/2" x 14	1 1/16 x 12	D	Black
741-08-12Z1	BSP 1/2" x 14	1 1/16 x 12	Z1	-
741-10-10D	BSP 5/8" x 14	7/8 x 14	D	-
741-10-10DBK	BSP 5/8" x 14	7/8 x 14	D	Black
741-10-10P	BSP 5/8" x 14	7/8 x 14	P	-
741-10-12D	BSP 5/8" x 14	1 1/16 x 12	D	-
741-10-12DBK	BSP 5/8" x 14	1 1/16 x 12	D	Black

Code	Thread A	Thread B	Mat	Note
741-10-12P	BSP 5/8" x 14	1 1/16 x 12	P	-
741-12-08P	BSP 3/4" x 14	3/4 x 16	P	-
741-12-10P	BSP 3/4" x 14	7/8 x 14	P	-
741-12-12D	BSP 3/4" x 14	1 1/16 x 12	D	-
741-12-12DBK	BSP 3/4" x 14	1 1/16 x 12	D	Black
741-12-12Z1	BSP 3/4" x 14	1 1/16 x 12	Z1	-
741-16-12P	BSP 1" x 11	1 1/16 x 12	P	-



763

BSP female to JIC male



Code	Thread A	Thread B	Mat	Note
763-03-03D	BSP 1/8" x 24	3/8 x 24	D	-
763-04-04P	BSP 1/4" x 19	7/16 x 20	P	-
763-04-06D	BSP 1/4" x 19	9/16 x 18	D	-
763-06-08D	BSP 3/8" x 19	3/4 x 16	D	-
763-08-06P	BSP 1/2" x 14	9/16 x 18	P	-
763-08-08P	BSP 1/2" x 14	3/4 x 16	P	-
763-08-10P	BSP 1/2" x 14	7/8 x 14	P	-

BSP MALE (GAS) TO METRIC MALE ADAPTORS



742

Metric concave seat

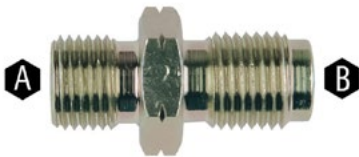

Code	Thread A	Thread B	Mat
742-03-31Z1	BSP 1/8" x 28	M10 x 1.00	Z1
742-03-M121Z1	BSP 1/8" x 28	M12 x 1.00	Z1
742-04-M121Z1	BSP 1/4" x 19	M12 x 1.00	Z1
742-04-M12P	BSP 1/4" x 19	M12 x 1.50	P
742-04-M14P	BSP 1/4" x 19	M14 x 1.50	P
742-08-M14P	BSP 1/2" x 14	M14 x 1.50	P
742-08-M16P	BSP 1/2" x 14	M16 x 1.50	P
742-08-M18P	BSP 1/2" x 14	M18 x 1.50	P



945

Metric convex seat



Code	Thread A	Thread B	Mat
945-03-31P	BSP 1/8" x 28	M10 x 1.00	P
945-03-M121P	BSP 1/8" x 28	M12 x 1.00	P

BSP ADAPTORS



313

Plug



Code	Thread A	Thread B	Mat
313-03P	BSP 1/8" x 28	-	P
313-04P	BSP 1/4" x 19	-	P
313-06P	BSP 3/8" x 19	-	P
313-08P	BSP 1/2" x 14	-	P
313-10P	BSP 5/8" x 14	-	P

METRIC ADAPTORS

B: Brass - C: Stainless steel - CH: Chrome plated - D: Aluminium - P: Zinc plated carbon steel - Z1: Silver plated carbon steel



Metric male equal convex



Code	Thread A	Thread B	Mat
145-31Z1	M10 x 1,00	M10 x 1,00	Z1



Metric unequal male concave seat



Code	Thread A	Thread B	Mat
148-31-M12C	M10 x 1,00	M12 x 1,50	C
148-M12-M14Z1	M12 x 1,50	M14 x 1,50	Z1
148-M14-M16P	M14 x 1,50	M16 x 1,50	P
148-M16-M18P	M16 x 1,50	M18 x 1,50	P
148-M18-M22P	M18 x 1,50	M22 x 1,50	P



Metric equal male concave seat



Code	Thread A	Thread B	Mat
149-M12P	M12 x 1,50	M12 x 1,50	P
149-M14P	M14 x 1,50	M14 x 1,50	P
149-M16P	M16 x 1,50	M16 x 1,50	P
149-M18P	M18 x 1,50	M18 x 1,50	P



Plug



Code	Thread A	Thread B	Mat
314-21SD	M8 x 1,00 - socket head	-	D
314-31P	M10 x 1,00	-	P
314-31SDBK	M10 x 1,00 - socket head	-	D - black
314-M122P	M12 x 1,25	-	P
314-M12D	M12 x 1,50	-	D
314-M14D	M14 x 1,50	-	D
314-M14P	M14 x 1,50	-	P
314-M14SD	M14 x 1,50 - socket head	-	D
314-M16P	M16 x 1,50	-	P
314-M22P	M22 x 1,50	-	P

METRIC & JIC/UNF BANJO ADAPTORS AND BANJO BOLTS



Single banjo adaptor



Code	Hole size	Thread	Mat	Note
776-03-04C	7/16"	3/8 x 24	C	-
776-03-04CH	7/16"	3/8 x 24	CH	-
776-03-04Z1	7/16"	3/8 x 24	Z1	-
776-03C	3/8", 10 mm	3/8 x 24	C	-
776-03CH	3/8", 10 mm	3/8 x 24	CH	-
776-03D	3/8", 10 mm	3/8 x 24	D	-
776-03Z1	3/8", 10 mm	3/8 x 24	Z1	-
776-04-03Z1	3/8"	7/16 x 20	Z1	-
776-04-M12D	12 mm	7/16 x 20	D	-
776-04-M12DBK	12 mm	7/16 x 20	D	Black
776-04-M12Z1	12 mm	7/16 x 20	Z1	-
776-04-M14D	14 mm	7/16 x 20	D	-
776-04-M14DBK	14 mm	7/16 x 20	D	Black
776-04Z1	7/16"	7/16 x 20	Z1	-
776-06-04D	7/16"	9/16 x 18	D	-
776-06-04DBK	7/16"	9/16 x 18	D	Black
776-06D	9/16"	9/16 x 18	D	-
776-06DBK	9/16"	9/16 x 18	D	Black
776-06-M12D	12 mm	9/16 x 18	D	-
776-06-M12DBK	12 mm	9/16 x 18	D	Black
776-06-M14D	14 mm	9/16 x 18	D	-
776-06-M14DBK	14 mm	9/16 x 18	D	Black
776-06-M16D	16 mm	9/16 x 18	D	-
776-06-M16DBK	16 mm	9/16 x 18	D	Black
776-08-M14D	14 mm	3/4 x 16	D	-
776-08-M14DBK	14 mm	3/4 x 16	D	Black
776-08-M16D	16 mm	3/4 x 16	D	-
776-08-M16DBK	16 mm	3/4 x 16	D	Black
776-08-M18D	18 mm	3/4 x 16	D	-

Code	Hole size	Thread	Mat	Note
776-08-M18DBK	18 mm	3/4 x 16	D	Black
776-10-M18D	18 mm	7/8 x 14	D	-
776-10-M20D	20 mm	7/8 x 14	D	-



Twin banjo adaptor



Code	Hole size	Thread	Mat	Note
779-03C	3/8", 10 mm	3/8 x 24	C	-
779-03Z1	3/8", 10 mm	3/8 x 24	Z1	-
779-06-04D	7/16"	9/16 x 18	D	-
779-06-04DBK	7/16"	9/16 x 18	D	Black



Single banjo bolt JIC



Code	Thread	Mat	To suit banjo	Note
775-04C	7/16 x 20	C	-04	-
775-04CH	7/16 x 20	CH	-04	-
775-04D	7/16 x 20	D	-04	-
775-04LZ1	7/16 x 20	Z1	-04	Long (25 mm under hex)
775-04Z1	7/16 x 20	Z1	-04	-
775-06D	9/16 x 18	D	-06	-
775-44BK	7/16 x 24	Mild steel	-04	Black
775-44C	7/16 x 24	C	-04	-
775-44CBK	7/16 x 24	C	-04	Black
775-44Z1	7/16 x 24	Z1	-04	-



Single banjo bolt metric



Code	Thread	Mat	To suit banjo	Note
992-04-M121D	M12 x 1,00	D	-04	-
992-04-M121DBK	M12 x 1,00	D	-04	Black
992-04-M121SC	M12 x 1,00	C	-04	Short (25 mm under hex)
992-04-M121SZ1	M12 x 1,00	Z1	-04	-
992-04-M121Z1	M12 x 1,00	Z1	-04	-
992-04-M122D	M12 x 1,25	D	-04	-
992-04-M122DBK	M12 x 1,25	D	-04	Black
992-04-M122Z1	M12 x 1,25	Z1	-04	-
992-04-M12C	M12 x 1,50	C	-04	-
992-04-M12CH	M12 x 1,50	CH	-04	-
992-04-M12D	M12 x 1,50	D	-04	-
992-04-M12DBK	M12 x 1,50	D	-04	Black
992-06-M12D	M12 x 1,50	D	-06	-
992-06-M12DBK	M12 x 1,50	D	-06	Black
992-06-M141D	M14 x 1,00	D	-06	-
992-06-M142D	M14 x 1,25	D	-06	-
992-06-M142DBK	M14 x 1,25	D	-06	Black
992-06-M14D	M14 x 1,50	D	-06	-
992-06-M14DBK	M14 x 1,50	D	-06	Black
992-06-M16D	M16 x 1,50	D	-06	-
992-06-M16DBK	M16 x 1,50	D	-06	Black
992-08-M16D	M16 x 1,50	D	-08	-
992-08-M16DBK	M16 x 1,50	D	-08	Black
992-08-M18D	M18 x 1,50	D	-08	-
992-08-M18DBK	M18 x 1,50	D	-08	Black

SPECIAL ADAPTORS

B: Brass - C: Stainless steel - CH: Chrome plated - D: Aluminium - P: Zinc plated carbon steel - Z1: Silver plated carbon steel



Straight o'ring boss to JIC male



Code	Thread A	Thread B	Hole size	Mat
AN920-04D	7/16 x 20	7/16 x 20	-	D
AN920-04DBK	7/16 x 20	7/16 x 20	-	D - Black
AN920-06-10D	9/16 x 18	7/8 x 14	-	D
AN920-06D	9/16 x 18	9/16 x 18	-	D
AN920-06DBK	9/16 x 18	9/16 x 18	-	D - Black
AN920-08-10D	3/4 x 16	7/8 x 14	-	D
AN920-08-10DBK	3/4 x 16	7/8 x 14	-	D - Black
AN920-08D	3/4 x 16	3/4 x 16	-	D
AN920-08DBK	3/4 x 16	3/4 x 16	-	D - Black
AN920-10-08D	7/8 x 14	3/4 x 16	-	D
AN920-10-08DBK	7/8 x 14	3/4 x 16	-	D - Black
AN920-10D	7/8 x 14	7/8 x 14	-	D
AN920-10DBK	7/8 x 14	7/8 x 14	-	D - Black
AN920-12D	1 1/16 x 12	1 1/16 x 12	-	D



JIC male to male with female NPT in hex



Code	Thread A	Thread B	Hole size	Mat
FBM2183	9/16 x 18	9/16 x 18	1/8"	D
FP190	9/16 x 18	9/16 x 18	1/8"	D
FP191	3/4 x 16	3/4 x 16	1/8"	D



JIC female to male with female NPT in hex



Code	Thread A	Thread B	Hole size	Mat
FP192	9/16 x 18	9/16 x 18	1/8"	D
FP193	3/4 x 16	3/4 x 16	1/8"	D

GAUGE ADAPTORS



Fuel and oil pressure gauge fittings

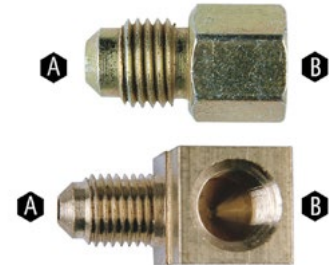

Code	Thread A	Thread B	Mat
GA-3	Male -03AN	Female 1/8 NPT	P
GA-4	Male -04AN	Female 1/8 NPT	P
GA-903	Male -03AN	90° female 1/8 NPT	P

BRAKE ADAPTORS



Male - Female adaptor



Code	Thread A	Thread B	Mat	Note
FM10100-031	3/8 x 24	10 x 1.00	P	Female concave
FM10100-03Z1	3/8 x 24	10 x 1.00	Z1	Female convex
FM10100-04	7/16 x 20	10 x 1.00	P	Female convex



Brake adaptor



Code	Thread A	Thread B	Mat	Note
FM10150-03FZ1	3/8 x 24	10 x 1.50	Z1	Female convex



Male - Female adaptor

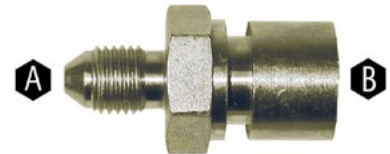

Code	Thread A	Thread B	Mat	Note
FM10716-03Z1	3/8 x 24	7/16 x 24	Z1	Female convex
FM10716-04	7/16 x 20	7/16 x 24	Z1	Female convex



Male - Female adaptor



Code	Thread A	Thread B	Mat	Note
FM10125-03	3/8 x 24	10 x 1.25	P	Female convex



Male - Female adaptor



Code	Thread A	Thread B	Mat	Note
FM10324-03	3/8 x 24	3/8 x 24	P	Female convex
FM10324-04	3/8 x 24	7/16 x 20	P	Female convex



Stainless Steel wire
Aircraft grade 302 Stainless Steel lock wire manufactured to military specifications. Ideal for positioning hoses or mounting hardware. Use with lock wire twisting pliers for quick and easy installation.
Material: Stainless Steel
Application: Prevents fasteners from vibrating loose. Can also be used as a visual check.
Package weight: 0.45KG

Code	Diameter
LWD594	0,45 mm
LWD595	0,51 mm
LWD596	0,62 mm
LWD597	0,81 mm
LWD598	1,01 mm



Flaring mandrel
Application: The mandrel is used to open the wire braid and bore of the PTFE ready for fitting the olive.



Code	Colour	To suit
GM100	Red	600-03
GM100MTB	Gold	-02
GM102	Blue	-02
GM104	Gold	-04



Socket plate
Application: the socket plate is used to pull the socket over the wire braid and olive prior to final assembly. The socket plate saves time when used with multiple hose assemblies.



Clamps
Aircraft quality P-Clips to support and locate hoses inside and outside the vehicle. Secured by rivet or bolt. AN-04 and AN-05 fittings are available in a range of anodised colours.
Material: D = Aluminium
Anodised Aluminium Colours:
BU = Blue, GD = Gold, RD = Red
Example Part No:
PLCC-03GD = Anodised Aluminium Gold

Code	To suit hose	Color	Bore size
PLCC-03	600-02	Aluminium	3/16"
PLCC-04	600-03	Aluminium	1/4"
PLCC-04DBU	600-03	Blue	1/4"
PLCC-04DRD	600-03	Red	1/4"
PLCC-05	600-04 -03 covered	Aluminium	5/16"
PLCC-05DBU	600-04 & -03 covered	Blue	5/16"
PLCC-05DRD	600-04 & -03 covered	Red	5/16"
PLCC-06	600-05	Aluminium	3/8"
PLCC-08	200-06	Aluminium	1/2"
PLCC-10	200-08	Aluminium	5/8"
PLCC-12	200-10	Aluminium	3/4"
PLCC-14	200-14	Aluminium	7/8"
PLCC-16	200-12	Aluminium	1"
PLCC-20	200-16	Aluminium	1 1/4"
PLCC-24	200-20	Aluminium	1 1/2"



Wire twisting pliers
Safety Lock Wire Pliers are a quick and easy way to install lockwire without the hassle of using a set of standard pliers or twisting by hand. The pliers lock closed to grip the wire and can be spun with a single hand for hard to access areas. A neat and equally spaced twist is easily achieved. In addition, the jaws are sprung loaded and feature a hardened cutting edge to finish the job.
Application: Compatible with all grades of lock wire.



Code	Length
PG6	6"
PG9	9"



Alloy Spanners
Hard anodised alloy wrenches specifically designed for use with Goodridge alloy hose ends and adaptors. Short handles allow use in confined spaces and discourage overtightening. Available in both double ended and single ended designs. See hex. in table.
AW760-SET contains wrenches from -04 to -12

Code	Exagon
AW760-04D	14,28 & 15,88
AW760-06D	17,46 & 19,05
AW760-08D	19,05 & 22,22
AW760-10D	25,40 & 26,99
AW760-12D	30,16 & 31,75
AW760-16D	36,51 & 38,10
AW760-SET	5 pieces kit - from 14,28 to 31,75 (-04/-12)



Hose Separators
Available in a range of dash sizes to suit your application, not only are hose separators ideal for a neat and tidy installation, but also ensure hoses are routed correctly, away from moving parts. Manufactured from billet aluminium and available in three anodised colours.
Fitting Type: Hose separator
Application: Locating and routing hoses
Material: D = Aluminium
To suit hose: G-Line Ultra, G-Line, 200, 210 and 600

Code	To suit hose	Color
PHS-03CL	600-03	White
PHS-03CL-CF	600-03 colourflex	White
PHS-03DB-CF	600-03 colourflex	Blue
PHS-03DR	600-03	Red
PHS-06DB	200-06	Blue
PHS-06DR	200-06	Red
PHS-08DB	200-08	Blue



PROTECTION SHEATHS



Spiral Binding
A flexible reinforced polythene spiral binding; provides protection to both hose and paint work.
Application: Hose protection
Material: Reinforced Polythene
To suit hose: 200, 210, 600
Colour: Black

Code	Colour	To suit hose
FRP-2BK	Black	600-03/-04



Reinforced Plastic
To suit Motocross and Enduro applications, this hard-plastic tubing can be used over your flexible hose and attached to the fork leg or rear swingarm.
Application: Protective/Rigid covering
Material: Reinforced Plastic
To suit hose: 600-03
Colour: Black

Code	Colour	To suit hose
HP-03BK	Black	600-03



HEATSHRINK



Raychem

Popular amongst motorsport applications; Raychem is a heat shrink covering offering flexibility, chemical and abrasion resistance. **(Glue impregnated and thin wall versions available on request)**

- Long-term fluid and heat resistance
- Resistance to fuels and hydraulic fluids
- Flexible
- Flame-retardant

Application:

Heat, abrasion and chemical resistant covering. Withstands temperatures from -75°C to 150°C.

Material:

Raychem

To suit hose:

600, 200, 210, 910, 811

Colour:

Black

Code	To suit hose	Color
DR-25-1	200-10/-12	Black
DR-25-1/2	200-06	Black
DR-25-1/4	600-02	Black
DR-25-3/4	200-06/-08	Black
DR-25-3/8	600-03/-04	Black



PVC

Self-extinguishing PVC protective heat shrink, provides protection against corrosion and abrasion.

This tough, hard wearing material may be fitted to braided hose or any other automotive component and shrunk to size by hot air, with a maximum reduction of 35% of original size.

Application:

Protective covering

Material:

PVC

To suit hose:

600, 200, 910

Colour:

Black = BK

Clear = CL

Code	To suit hose	Color
HS760-03BK	600-03/-04	Black
HS760-03CL	600-03/-04	Transparent
HS760-06BK	200-04/-06/-08	Black
HS760-06CL	200-04/-06/-09	Transparent
HS760-10BK	200-10	Black



FLAMEGUARDS AND FIREPROOF SLEEVES



EKC622

Flameguard. A glass cloth with an aluminium foil surface on one side. Its lightweight construction makes it a very popular heat and fire protector. It is now also available with aramid fibre reinforced cloth for ultimate strength.

Application temperature:

-36°C to 180°C

Code	To suit hose	Ext. hose Ø
EKC622-04	600-02/-03/-04	1/2"
EKC622-08	200-06/-08	3/4"
EKC622-12	200-10/-12	1"
EKC622-16	200-16	1 1/4"



FG900

Goodridge braided fire sleeve is engineered for both long-term and short-term exposure to varying degrees of heat.

The thick layer of self-extinguishing silicone polymer shields direct flame exposure, shedding molten metal and glass, whereas the texturized braided fibreglass insulating inner core maintains and stabilises internal temperature whilst minimising surface temperature. Resistant to lubricating oils, fuels, hydraulic fluid, acids, bases and solvents.

Application:

Hose Insulation and Fire Retardant

Temperature:

Continuous: 500°F / 260°C

Intermittent: 2200°F / 1200°C

Minimum: -65°F / -54°C

Material:

Silicone & Fibreglass

To suit hose:

All - Flexible and expandable

Colour:

Silver

Code	To suit hose	Ext. hose Ø
FG900-04S	600-02/-03/-04	05 - 08 mm
FG900-06S	200-04/600-06	10 - 12 mm
FG900-08S	200-06/600-08	12 - 15 mm
FG900-12S	200-08/-10	16 - 21 mm
FG900-16S	200-12	21 - 24 mm
FG900-20S	200-16	25 - 30 mm



TEXTALU

An insulative fibreglass sleeving with a silicone coating designed to protect components in high temperature areas where the heavier fireproof sleeving is not required. It provides superior insulation to components that must maintain stable temperatures to assure performance efficiency. Its braided construction allows good flexibility in temperatures as low as -40°C.

Applications:

- Wire harnesses
- Electrical cables
- Sensor wirings
- Control cables
- Tubings

Code	To suit hose	Ext. hose Ø
TEXTALU-10MM	600-06	10 mm
TEXTALU-12MM	200-04	12 mm
TEXTALU-15MM	200-06	15 mm
TEXTALU-22MM	200-08/-10	22 mm
TEXTALU-5MM	600-02	5 mm
TEXTALU-8MM	600-03/-04	8 mm



WASHERS



The stat-o-seal is the best sealing washer available. Consisting of a synthetic rubber O-Ring mechanically locked in the ID of an aluminium crush washer. This provides the advantages of an O-Ring seal, but with the ease of fitting.

Application: Aluminium fittings
Material: Aluminium and rubber
Temperature: -30°C / -22°F to 233°C / 450°F



Code	Mat	Bore size	Thickness	Braid outer Ø
SS902-04	Aluminium	1/4"	1,25 mm	12,7 mm
SS902-05	Aluminium	5/16"	1,25 mm	15,3 mm
SS902-06	Aluminium	3/8"	1,25 mm	16,9 mm
SS902-07	Aluminium	7/16"	1,25 mm	19,2 mm
SS902-08	Aluminium	1/2"	1,25 mm	22,2 mm
SS902-09	Aluminium	9/16"	1,25 mm	27,0 mm
SS902-12	Aluminium	3/4"	1,5 mm	33,4 mm
SS902-14	Aluminium	7/8"	1,5 mm	28,3 mm



Copper sealing washers for use with Z1, chrome plated steel, mild steel and stainless fittings.
 Aluminium sealing washer for use with aluminium fittings.

Application:
 Copper washers: all stainless steel fittings
 Aluminium washers: aluminium fittings
Material:
 Copper washers: copper
 Aluminium washers: aluminium



Code	Mat	Bore size	Thickness	Braid outer Ø
44515	Aluminium	0,400"	0,050"	0,590"
44518	Copper	0,437"	0,050"	0,685"
CW901-04	Aluminium	0,443"	0,050"	0,683"
CW901-06	Aluminium	0,568"	0,050"	0,808"
CW901-08	Aluminium	0,755"	0,050"	0,995"
CW901-10	Aluminium	0,880"	0,050"	1,120"
CW901-12	Aluminium	1,068"	0,050"	1,370"
44516	Copper	10,00 mm	0,050"	0,590"
44517	Copper	10,00 mm	2,0 mm	14,0 mm
44550	Steel	10,60 mm	2,0 mm	19,60 mm
44518HD	Copper	11,50 mm	1,50 mm	16,00 mm
CW901-M12	Aluminium	12,2 mm	1,1 mm	17,9 mm
CUW-M12	Copper	12,25 mm	1,50 mm	16,00 mm
44519	Copper	12,50 mm	1,30 mm	15,00 mm
CUW-M14	Copper	14,40 mm	1,20 mm	18,40 mm
CW901-M14	Aluminium	14,5 mm	1,4 mm	19,0 mm
44520	Copper	14,50 mm	1,50 mm	18,00 mm
CUW-M16	Copper	16,00 mm	1,0 mm	22,50 mm
CW901-M16	Aluminium	16,3 mm	1,4 mm	19,8 mm
CW901-M18	Aluminium	18,2 mm	2,0 mm	21,2 mm
CUW-M18	Copper	18,20 mm	1,5 mm	21,78 mm
CUW-M22	Copper	22,30 mm	1,5 mm	26,80 mm
44512	Copper	6,30 mm	1,0 mm	9,80 mm
44514	Copper	8,00 mm	1,0 mm	11,00 mm



High quality bonded Dowty sealing washers in a range of sizes.

Application: Steel fittings
Material: Mild Steel and Nitrile
Temperature: -30°C / -22°F to 233°C / 450°F



Code	Mat	Bore size	Braid outer Ø	Note
DW-20A	Steel	0,407"	0,625"	BSP 1/8 - JIC 3/8 - Met 10 mm
DW-09	Steel	0,460"	0,750"	JIC 7/16 - Met 11 mm
DW-21B	Steel	0,540"	0,810"	BSP 1/4 - JIC 1/2 - Met 12 mm
DW-10	Steel	0,585"	0,875"	JIC 9/16 - Met 14 mm
DW-11	Steel	0,650"	1,000"	JIC 5/8 - Met 16 mm
DW-23C	Steel	0,679"	0,940"	BSP 3/8
DW-24CC	Steel	0,744"	1,060"	JIC 3/4 - Met 18 mm
DW-25D	Steel	0,847"	1,125"	BSP 1/2 - Met 20 mm
DW-26E	Steel	0,942"	1,250"	BSP 5/8 - JIC 7/8 - Met 22 mm
DW-27F	Steel	1,064"	1,375"	BSP 3/4 - JIC 1 - Met 24 mm
DW-28FF	Steel	1,095"	1,520"	JIC 1 1/16 - Met 26 mm

O-RINGS & LOCKNUTS



Fitting type: O-Ring
Application: Petroleum based products
To suit: AN920, AN921, AN922, AN814SD and G-Line swivel fittings
Please note: AN6290 compliant



Code	Section	int. Ø
OR6290-03	1,6 mm	7,65 mm
OR6290-04	1,8 mm	8,92 mm
OR6290-06	2,0 mm	11,89 mm
OR6290-08	2,2 mm	16,36 mm
OR6290-10	2,5 mm	19,18 mm
OR6290-12	2,9 mm	23,47 mm







Code	Thread	To suit	Mat
318-31C	M10 x 1,00	448-31 / 444-31	C
318-31Z1	M10 x 1,00	448-31 / 444-31	Z1
318-M121Z1	M12 x 1,00	446-03-M121 / 446-04-M121	Z1
924-03C	JIC 3/8 x 24	443-03	C
924-03Z1	JIC 3/8 x 24	443-03	Z1
924-04C	JIC 7/16 x 20	443-04	C
924-04Z1	JIC 7/16 x 20	443-04	Z1
924-06Z1	JIC 9/16 x 18	832-06	Z1

TECHNICAL INFORMATION

Note: Lubricate threads with duck oil before assembly (or a similar commercial lubricant may be used). Goodridge recommend that the finished assembly is fully pressure tested prior to use.

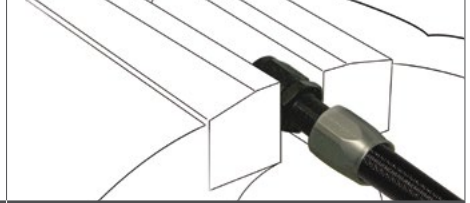
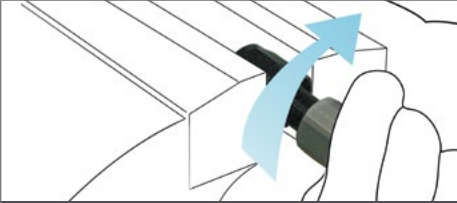
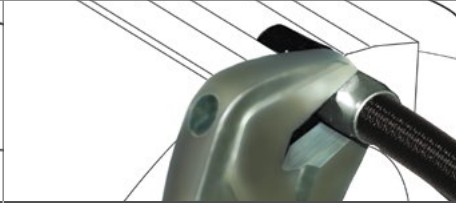
ASSEMBLY INSTRUCTIONS FOR 811 FITTINGS AND 910 SERIES HOSE

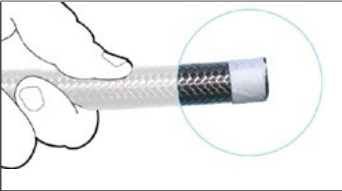
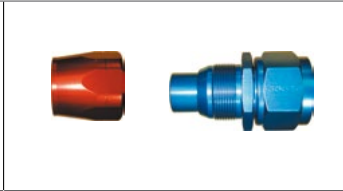
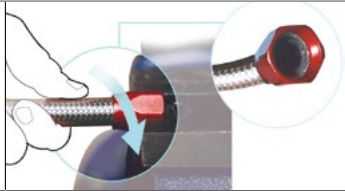
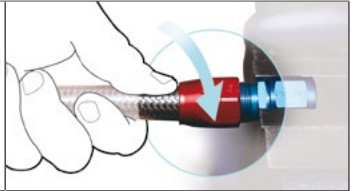
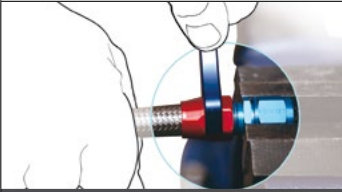
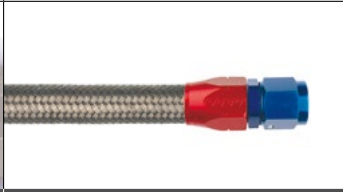

		
<p>STEP 1</p> <p>Remove socket from fitting and ensure the hose has clean square cut ends.</p>	<p>STEP 2</p> <p>Feed the hose into the socket with a turning motion, feeding the braid in as you turn the hose.</p>	<p>STEP 3</p> <p>Hold the fitting in a vice with smooth or soft jaws, and lubricate the threads with a light oil.</p>
		
<p>STEP 4</p> <p>Push the hose firmly onto the thread whilst rotating the hose and socket together. Hand tighten both the hose and socket until it becomes too tight to move.</p>	<p>STEP 5</p> <p>Finish tightening the socket using an aluminium spanner, continue turning the socket until it reaches the base of the thread.</p>	<p>STEP 6</p> <p>When the socket reaches the base of the thread keep turning for an extra 1.5 complete turns.</p>

ASSEMBLY INSTRUCTIONS FOR 236, 336 SERIES FITTINGS AND 200, 210 SERIES HOSE



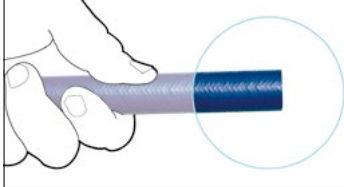
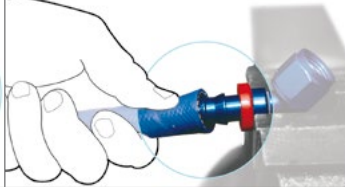

			
<p>STEP 1</p> <p>Bind masking tape tightly around the hose at the required length and cut through using a fine tooth saw blade or cut off wheel, leaving tape on both ends so that it retains the braid. Clean any debris from both the cut ends and inside the hose.</p>	<p>STEP 2</p> <p>Socket (red) Main fitting body (blue) On a clean flat surface disassemble the fitting. This consists of two parts. <i>Tip: Wrap some tape behind the socket to identify if the hose is being pushed out of the socket when tightening.</i></p>	<p>STEP 3</p> <p>Hold the socket in a smooth jaw vice and feed one end of the hose into the socket by turning clockwise and pushing until the hose finishes just behind the socket threads.</p>	<p>STEP 4</p> <p>Holding the main fitting body in the vice, lubricate the thread and push the hose and socket over the nipple end and start to thread the socket onto the fitting by hand.</p>
			
<p>STEP 5</p> <p>Finish tightening the socket onto the fitting using a good quality wrench until the socket is one full turn from the back of the of the fitting hex.</p>	<p>STEP 6</p> <p>Pressure test.</p>		

Note: Lubricate threads with duck oil before assembly (or a similar commercial lubricant may be used). Goodridge recommend that the finished assembly is fully pressure tested prior to use.

ASSEMBLY INSTRUCTIONS FOR TF-TU25 & 536 HOSE & PUSH FIT FITTINGS

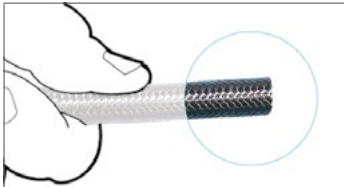
			
STEP 1	STEP 2	STEP 3	STEP 4
<p>Cut hose at the required length using a fine tooth saw blade or cut off wheel. Clean any loose debris from both the cut ends and inside the hose.</p>	<p>Hold the fitting in a bench vice, lubricate the fitting tail and inside the hose. Tip: <i>Submerge the end of the hose in hot water to soften and ease assembly.</i></p>	<p>Push the hose over the fitting tail until it is tight behind the red hose finisher.</p> 	<p>Please Note: Straight female fittings require the use of a male adaptor during hose assembly to stop the fitting tail turning.</p>

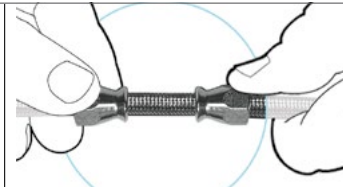

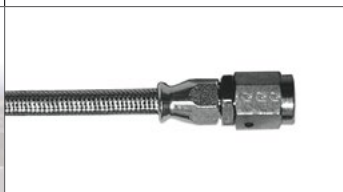

ASSEMBLY INSTRUCTIONS FOR RE-USABLE 600 SERIES (PTFE SMOOTH BORE) HOSE & FITTINGS

			
STEP 1	STEP 2	STEP 3	STEP 4
<p>Using a fine tooth saw blade or cut off wheel, cut hose to the required length. Clean any loose debris from both the cut ends and inside the hose. Note: Lubricate threads with Duck Oil before assembly. (or a similar commercial lubricant may be used)</p>	<p>Main fitting body - Olive - Socket On a clean flat surface disassemble the fitting, this consists of 3 parts, the Main fitting body, Olive and Socket.</p>	<p>Push two sockets back to back over the overbraid working from the non flared end</p>	<p>Using an appropriate sized Goodridge mandrel, flare out both ends of the stainless steel overbraid from the PTFE inner tube</p>
			
STEP 5	STEP 6	STEP 7	
<p>Push an olive onto each end of the PTFE inner tube under the stainless steel over braid by hand and finish off by pushing against a flat solid surface making sure the PTFE tube is fully home in the olive.</p>	<p>Holding the main fitting body in a smooth jaw vice, lubricate the thread and push the hose over the nipple end and start to thread the socket onto the fitting by hand.</p>	<p>Finish tightening the socket onto the fitting with a good quality spanner until the socket is one full turn from the main fitting hex.</p> <p>PRESSURE TEST</p>	<p>UNDER NO CIRCUMSTANCES SHOULD THE SOCKET BE LOOSENED IN AN ATTEMPT TO ADJUST THE ALIGNMENT AFTER ASSEMBLY</p>

TECHNICAL INFORMATION

Note: Lubricate threads with duck oil before assembly (or a similar commercial lubricant may be used). Goodridge recommend that the finished assembly is fully pressure tested prior to use.

ASSEMBLY INSTRUCTIONS FOR HARDLINE AND FITTINGS

			
STEP 1	STEP 2	STEP 3	STEP 4
Bend tube to suit installation using a hardline bending tool and observing the minimum bend radius (15mm for -4 and -6 tube)	Debur and remove any loose pieces of Hycot® cover. Measure and mark 21mm from the end of the hose.	Slide socket and olive onto hose until it reaches the 21mm mark made in step 2	Using an appropriate spanner, assemble the socket until the socket completely covers exposed threads (2mm - 2.5mm between socket and hex)
STEP 5	NOTES		
Assemble other end repeating steps 1-4 and pressure test assembly.	<p>1. Once assembled, the hardline fitting should NOT be loosened and re-assembled. The olive is permanently attached after assembly and cannot be removed.</p> <p>2. For production, we recommend building one template and copying all bends and dimensions from this master sample.</p>		

TECHNICAL INFORMATION

CORRECT ALIGNMENTS

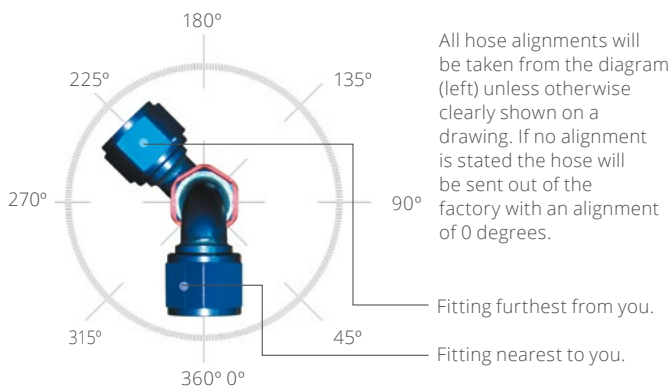

CORRECT MEASUREMENTS

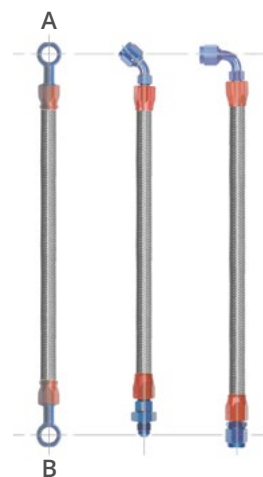

The following instructions are designed to eliminate confusion and ensure that correct hose lengths are supplied for assembly. When ordering hose assemblies please make sure the following instructions are followed. All measurements are taken from the center of seat **A** to the center of seat **B**. This will apply in all cases unless CLEAR instructions are given on purchase order or a drawing supplied.

HOSE LENGTH TOLERANCES

Hose length	Tolerance
100mm to 200mm	+3mm
200mm to 400mm	+5mm
400mm to 600mm	+6mm
600mm Upwards	+ 1%

Standard Goodridge hose tolerances used unless otherwise

HOSE ASSEMBLY INSTRUCTIONS

Wherever a hose assembly is used in either a static or dynamic flexing application, it is necessary to ensure that the center line bend radius is not taken below the minimum bend radius for the hose. Hose assemblies should not be installed in such a manner that a torque loading is imposed, either during installation, or in subsequent use. Torque loading of the hose creates stresses in the hose, which can shorten the hose life, or cause the hose to collapse. Whilst assembling the second end fitting, especially if it is a female union type or fitting, it is necessary to ensure that the final tightening of the nut does not also rotate the spigot, thus imposing the torque

to the hose. In the case of reusable fittings the hex on the body should be held with a spanner to prevent rotation. When the hose includes elbow fittings at both ends, it is important to ensure the correct alignment of the elbows relative to each other during hose manufacture. It is important to ensure that the hose is connected the right way round when installed. When the hose has an elbow at one end and a straight fitting the other end,

always connect the elbow end first, to prevent possible misalignment. In applications where the hose undergoes dynamic flexing, it is necessary to ensure that all bends in the hose are in one plane. A hose which is bent in two or more planes and then flexed is subject to torsional forces which may damage the hose.

Damage

Any visible evident damage to the hose, such as broken strands of braid, of severe distortion of the hose, or damage to the end fittings is cause for the hose to be withdrawn from service. The cause of the damage should then be identified, and steps taken to ensure that it does not re-occur.

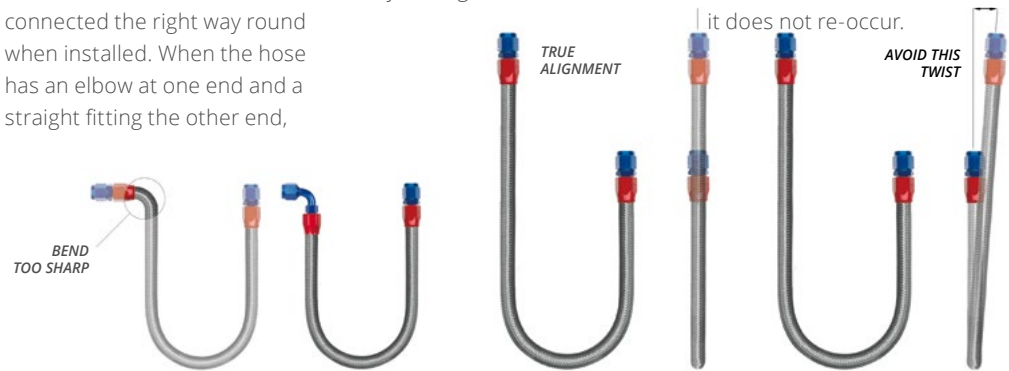

HOSE COVERING APPLICATION GUIDE

Hose	Fire sleeve	Raychem	Heatshrink	Raychem to seal ends of FG900	Hose	Fire sleeve	Raychem	Heatshrink	Raychem to seal ends of FG900
600					710/910				
600-02	FG900-03	DR-25-1/4	HS760-02		710/910-04	FG900-04	DR-25-1/2	HS760-06	DR-25-1
600-03	FG900-03	DR-25-3/8	HS760-03		710/910-06	FG900-08	DR-25-3/4	HS760-06	DR-25-1
600-04	FG900-03	DR-25-3/8	HS760-03		710/910-08	FG900-12	DR-25-1	HS760-10	DR-25-1
600-06	FG900-06	DR-25-3/4	HS760-06		710/910-10	FG900-16	DR-25-1	HS760-10	
600-08	FG900-08	DR-25-3/4	HS760-06		710/910-12	FG900-16			
					710/910-16	FG900-20			
510/810					200/210				
510/810-04	FG900-04	DR-25-1/2	HS760-06	DR-25-1	200/210-04	FG900-04	DR-25-1/2	HS760-06	DR-25-1
510/810-06	FG900-08	DR-25-3/4	HS760-06	DR-25-1	200/210-06	FG900-08	DR-25-3/4	HS760-06	DR-25-1
510/810-08	FG900-12	DR-25-1	HS760-10	DR-25-1	200/210-08	FG900-08	DR-25-3/4	HS760-06	DR-25-1
510/810-10	FG900-16	DR-25-1	HS760-10		200/210-10	FG900-12	DR-25-1	HS760-10	DR-25-1
510/810-12	FG900-16				200/210-12	FG900-12	DR-25-1		DR-25-1
510/810-16	FG900-20				200/210-16	FG900-16			

COMMON THREAD SIZES

Size	JIC/UNF	BSP	NPT	SIZE	JIC/UNF	BSP	NPT	SIZE	JIC/UNF	BSP	NPT
-02	5/16" x 24		1/16" x 27	-06	9/16" x 18	3/8" x 19	3/8" x 18	-16	1 5/16" x 12	1" x 11	1" x 11 1/2
-03	3/8" x 24	1/8" x 28	1/8" x 27	-07	5/8" x 18			-20	1.5/8" x 12	1 1/4" x 11	1 1/4" x 11 1/2
-04	7/16" x 20	1/4" x 19	1/4" x 18	-08	3/4" x 16	1/2" x 14	1/2" x 14	-24	1 7/8" x 12	1 1/2" x 11	1 1/2" x 11 1/2
-44	7/16" x 24			-10	7/8" x 14	5/8" x 14		-28	2 1/4" x 12	1 3/4" x 11	
-05	1/2" x 20			-12	1 1/6" x 12	3/4" x 14	3/4" x 14	-32	2 1/2" x 12	2" x 11	2" x 11 1/2
Metric	Thread			Metric	Thread			Metric	Thread		
-21	8 x 1.00			-M121	12 x 1.00			-M16	16 x 1.50		
-22	8 x 1.25			-M122	12 x 1.25			-M18	18 x 1.50		
-31	10 x 1.00			-M12	12 x 1.50			-M20	20 x 1.50		
-32	10 x 1.25			-M142	14 x 1.25			-M22	22 x 1.50		
-35	10 x 1.50			-M14	14 x 1.50			-M24	24 x 1.50		